

Better Service
Reasonable Price
Excellent Quality

LUCKY STORE SOLUTION
For the life of your business

We Design What You Dream



2022



LUCKY STORE SOLUTION
For the life of your business





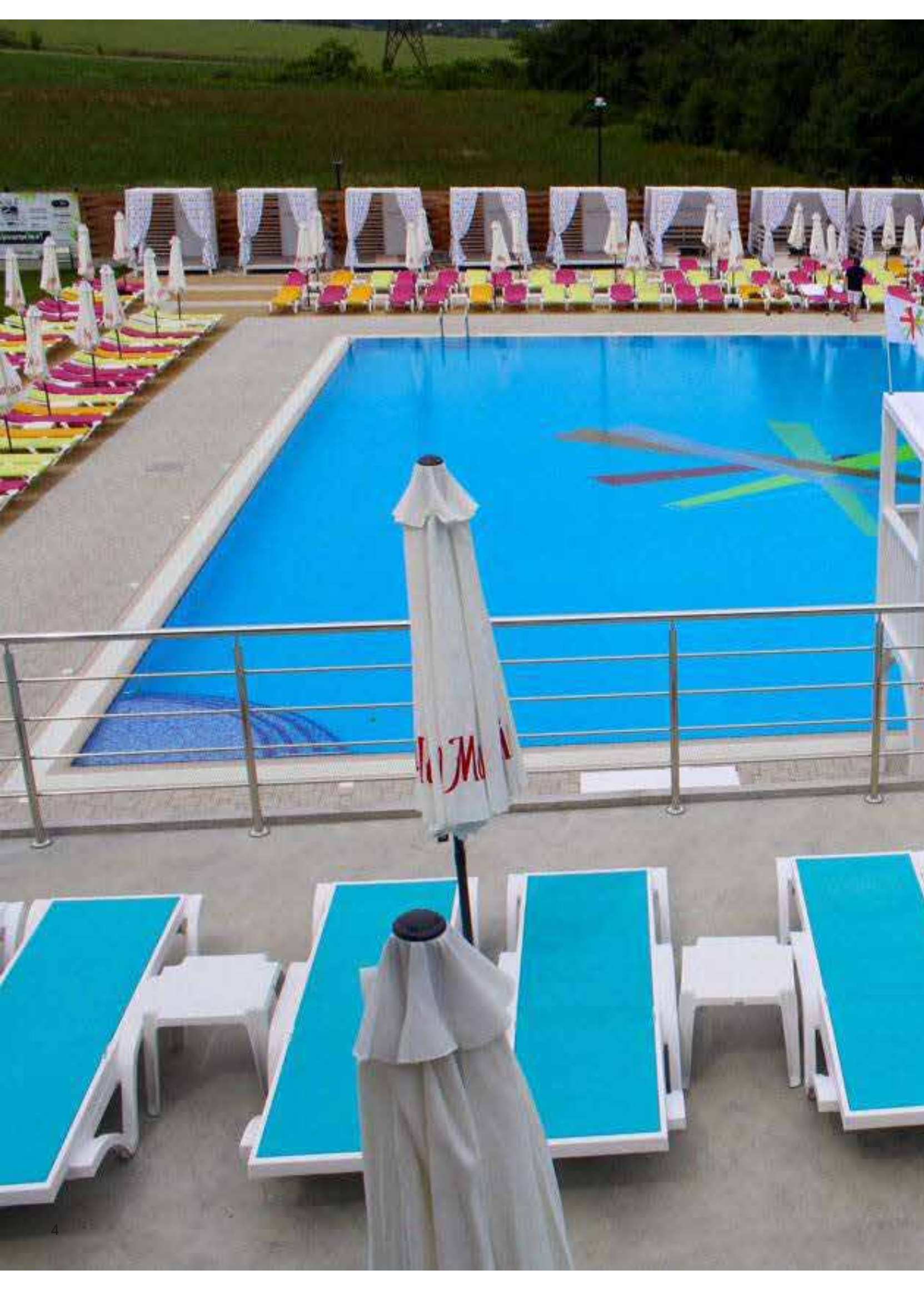



LUCKY STORE SOLUTION

For the life of your business



BLUBRELLA





BLUBRELLA YUVARLAK BLUBRELLA ROUND



İnhaçenizde, havuz kenarında, reklamlarınızda veya balkonda kullanmanız için üretilmiş 6 kollu yuvarlak alüminyum şemsiyedir. Kullanılan alüminyum gövde rengini isterseniz beyaz isterseniz eloksal olarak seçebilirsiniz. İskelette bulunan plastik parçalar, tüm dünyada şemsiye üretiminde kullanılan kırılmaya karşı 2 yıl garantili ABS ve POLYAMID PA6 PRİME hammadde kullanılarak üretilmiştir. Şemsiyenizin rüzgar tahliyesi tepe kısmında bulunan hava pencereleri ile yapılabildiği için şemsiyenizi rüzgarlı havalarda güvenle kullanabilirsiniz. Birbirine geçebilen çift borular mandal sistemi ile sıkıştırılarak istenilen yükseklikte ayarlanabilir. Kullanımı son derece basit olup, orta boru üzerinde bulunan kolların bağlı olduğu ana gövdenin yukarı doğru sürülmesi ile kolların ters açıda kumaşı girmesi sonucu şemsiyeniz otomatik olarak sabitlenerek kullanıma hazır hale gelir. Uygun altlık (Bakınız syf. 7 ve 74-75) ve 160 gr akrilik kaplamalı polyester veya 250 gr olefin kumaş (5 yıl garantili) ile sizi yıllarca güneşten koruyabilir.

Blubrella round is a aluminum parasol with 6 ribs which can be produced for Garden, Balcony,Advertesiment,and Pool Edges.

All plastic Parts in the frame 2 year warranty against Brekage,used in Produktion row Materials same as all over the World, which are manufactured from ABS and POLYAMID PA6 Prime

If you want if you can choose colour or anodized for aluminum Frame.

Double Pipes can pass eachother with a latch system can be compressed to the desired height

It is extremely easy to set up your Parasol: put up the Frame to the centre Pole and then your Parasol becomes ready automatically.

The Wind can be evacuated by air window in the top of the Parasol and it has a dual roof.

You can use safety your Parasol in the windy Weather.

250 gr Olefin, (5 year warranty) and 160 gr acrylic waterproof polyester Fabric protect you from the Sun for years.

Bases (you can find them on the next and 74-75 th Pages)





Aluminium Etial 60
Plastic Material: ABS / PA6

	BLR 200/6	BLR 250/6	BLR 275/6
Boyut / Size	Ø 200 cm	Ø 250 cm	Ø 275 cm
Üst Boru / Upper pipe	Ø 35,8x38,2 mm	Ø 35,8x38,2 mm	Ø 35,8x38,2 mm
Alt Boru / Bottom pipe	Ø 39x41 mm	Ø 39x41 mm	Ø 39x41 mm
Profil / Ribs	13x19 mm	13x19 mm	13x19 mm
Paketleme / Factory Pack	1	1	1

Teknik Özellikleri / Technical Specifications

Ölçü / Size	Kapalı Alan / Area Covered	Ağırlık / Weight	Ambalaj / Packaging
A	B m²	Kg	Cm
200/6	3	5	16x16x130
250/6	5	7	16x16x150
275/6	6	8	16x16x155

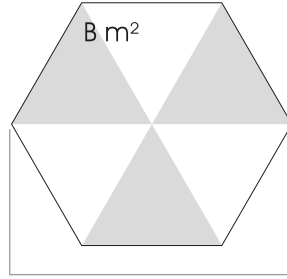

6 Parts A

Profiller / Profiles

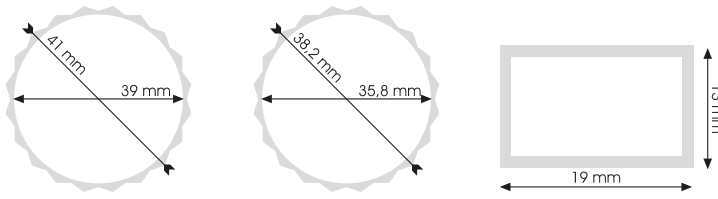

BLUBRELLA KARE BLUBRELLA SQUARE



Bahçenizde, havuz kenarında, reklamlarınızda veya balkonda kullanmanız için üretilmiş 4 kollu kare alüminyum şemsiyedir. Kullanılan alüminyum gövde rengini isterseniz beyaz isterseniz eloksal olarak seçebilirsiniz. İskelette bulunan plastik parçalar, tüm dünyada şemsiye üretiminde kullanılan kırılmaya karşı 2 yıl garantili ABS ve POLYAMID PA6 PRİME hammadde kullanılarak üretilmiştir. Şemsiyenizin rüzgar tahliyesi tepe kısmında bulunan hava pencereleri ile yapılabildiği için şemsiyenizi rüzgarlı havalarda güvenle kullanabilirsiniz. Birbirine geçebilen çift borular mandal sistemi ile sıkıştırılarak istenilen yükseklikte ayarlanabilir. Kullanımı son derece basit olup, orta boru üzerinde bulunan kolların bağlı olduğu ana gövdenin yukarı doğru sürülmesi ile kolların ters açıda kumaşı girmesi sonucu şemsiyeniz otomatik olarak sabitlenerek kullanıma hazır hale gelir.

Uygun altlık (Bakınız syf. 9 ve 74-75) ve 160 gr akrilik kaplamalı polyester veya 250 gr olefin kumaş (5 yıl garantili) ile sizi yıllarca güneşten koruyabilir.

Blubrella square is a aluminum parasol with 6 ribs which can be produced for Garden, Balcony,Advertesiment,and Pool Edges.

All plastic Parts in the frame 2 year warranty against Brekage,used in Produktion row Materials same as all over the World, which are manufactured from ABS and POLYAMID PA6 Prime

if you want if you can choose colour or anodized for aluminum Frame.

Double Pipes can pass eachother with a latch system can be compressed to the desired height

it is extremely easy to set up your Parasol: put up the Frame to the centre Pole and then your Parasol becomes ready automatically.

The Wind can be evacuated by air window in the top of the Parasol and it has a dual roof.

You can use safety your Parasol in the windy Weather.

250 gr Olefin, (5 year warranty) and 160 gr acrylic waterproof polyester Fabric protect you from the Sun for years.

Bases (you can find them on the next and 74-75 th Pages)

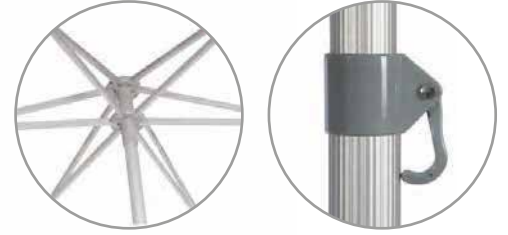

Aluminium Etial 60
Plastic Material: ABS / PA6

BLS 170x170/4

BLS 200x200/4

BLS 250x250/4

Boyut / Size	Ø 170x170 cm	Ø 200x200 cm	Ø 250x250 cm
Üst Boru / Upper pipe	Ø 35,8x38,2 mm	Ø 35,8x38,2 mm	Ø 35,8x38,2 mm
Alt Boru / Bottom pipe	Ø 39x41 mm	Ø 39x41 mm	Ø 39x41 mm
Profil / Ribs	13x19 mm	13x19 mm	13x19 mm
Paketleme / Factory Pack	1	1	1

Teknik Özellikleri / Technical Specifications

Ölçü Size	Kapalı Alan Area Covered	Ağırlık Weight	Ambalaj Packaging
A	B m²	Kg	Cm
170x170/4	3	5,5	16x16x150
200x200/4	4	6	16x16x160
250x250/4	6,25	8	16x16x205

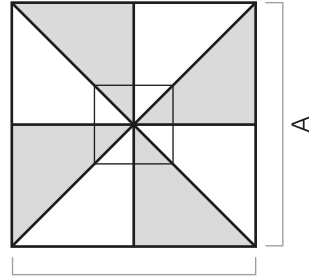

4 Parts A

Profiller / Profiles

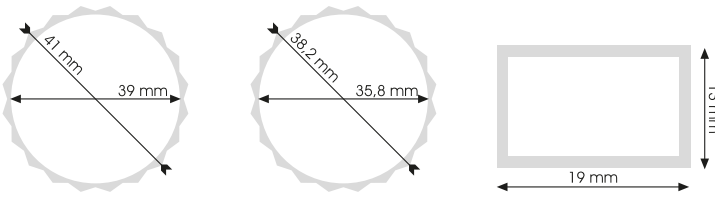



LUCKY STORE SOLUTION
For the life of your business





SUNMINIUM YUVARLAK SUNMINIUM ROUND

Bahçenizde, havuz kenarında kullanabileceğiniz yuvarlak 8 kollu alüminyumdan üretilmiş şemsiyedir.

Beyaz renkli elektrostatik boya (RAL 9010) ile kaplanarak üretilen şemsiyenizin orta borusu 40 mm'dir.

*İskelette bulunan plastik parçalar, tüm dünyada şemsiye üretiminde kullanılan kırılmaya karşı 2 yıl garantili ABS ve POLYAMID PA6 PRİME hammadde kullanılarak üretilmiştir.

Şemsiyenizin rüzgar tahliyesi tepe kısmında bulunan hava pencereleri ile yapılabilirdiği için şemsiyenizi rüzgarlı havalarda güvenle kullanabilirsiniz.

Şemsiyenizi açmak için orta boru üzerinde bulunan plastik gövde mandalını bastırarak yukarı doğru hareketlendirmeniz ve boruda bulunan yuvaya emniyet pimini otomatik olarak oturtmanız yeterlidir.

Kapaması ise mandalın bastırılarak emniyet piminin yuvasından çıkması ile kolayca yapılabilir.

Uygun altlık (Bakınız sayfa 13 ve 74-75) ve 160 gr polyester veya 250 gr olefin (5 yıl garantili) kumaş seçeneği ile sizi yıllarca güneşten koruyabilir.

Sunminyum; round is a aluminum parasol.

All plastic Parts in the Frame 2 year warranty against Brekage,used in Produktion row Materials same as all over the World, which are manufactured from ABS and POLYAMID PA6 Prime. Centre Pole is 40 diameter and white powder paint coated.

Press a button then push it up to open your Parasol to use it The Wind can be evacuated by air window in the top of the Parasol. You can use safety your Parasol in the windy Weather.

250 gr Olefin, (5 year warranty) and 160 gr acyrllic waterproof polyester Fabric protect you from the Sun for years.

Bases (you can find them on the next and 74-75 th pages)



SMR 200/8

SMR 225/8

SMR 250/8

Boyut / Size
Boru / Tube
Profil / Ribs
Paketleme / Factory Pack

Ø 200 cm
Ø 40/37 mm
13x19 mm
4

Ø 225 cm
Ø 40/37 mm
13x19 mm
4

Ø 250 cm
Ø 40/37 mm
13x19 mm
4

Teknik Özellikleri / Technical Specifications

Ölçü Size	Kapalı Alan Area Covered	Kapalı Yükseklik Height Closed	Etek Yüksekliği Clear Headroom	Açık Yükseklik Height Open	Ambalaj Packaging
A	B m ²	C cm	D cm	E cm	Cm
200/8	3	110	163	220	27x27x250
225/8	4	110	163	220	27x27x250
250/8	5	90	183	220	27x27x250

Profiller / Profiles

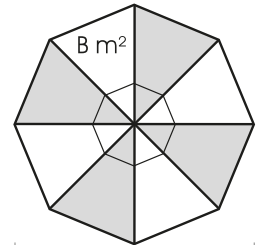
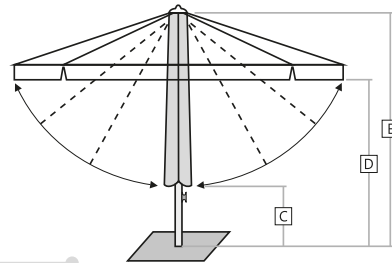
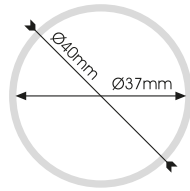
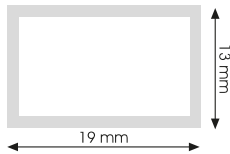

8 Parts A



ODS DELUX 50
50x50 cm. / 80 kg



ODS 120
50x50 cm / 80 kg



SÜPER TKR/2412
50 kg Betonlu Altlık



MEGA-S 2310
50 tl. Bidon



Fonksiyonlu Masa
Ø 50 cm



ODS 141 KÜLLÜK
Ø 16 cm

SUNMINIUM KARE SUNMINIUM SQUARE



Bahçenizde, havuz kenarında kullanabileceğiniz 8 kollu kare alüminyumdan üretilmiş şemsiyedir.

Beyaz renkli elektrostatik boya (RAL 9010) ile kaplanarak üretilen şemsiyenizin orta borusu Ø40 mm'dir.

*İskelette bulunan plastik parçalar, tüm dünyada şemsiye üretiminde kullanılan kırılmaya karşı 2 yıl garantili ABS ve POLYAMID PA6 PRİME hammadde kullanılarak üretilmiştir.

Şemsiyenizin rüzgar tahliyesi tepe kısmında bulunan hava pencereleri ile yapılabilirdiği için şemsiyenizi rüzgarlı havalarda güvenle kullanabilirsiniz.

Şemsiyenizi açmak için orta boru üzerinde bulunan plastik gövde mandalını bastırarak yukarı doğru hareketlendirmeniz ve boruda bulunan yuvaya emniyet pimini oturtmanız yeterlidir.

Kapaması ise mandalın bastırılarak emniyet piminin yuvasından çıkması ile kolayca yapılabilir.

Uygun altlık (Bakınız syf 15 ve 74-75) ve 160 gr polyester veya 250 gr olefin (5 yıl garantili) kumaş seçeneği ile sizi yıllarca güneşten koruyabilir.

Sunminyum; square is a aluminum Parasol .

All plastic Parts in the Frame 2 year warranty against Brekage,used in Produktion row Materials same as all over the World, which are manufactured from ABS and POLYAMID PA6 Prime. Centre Pole is 40 diameter and white powder paint coated.

Press a button then push it up to open your Parasol to use it The Wind can be evacuated by air window in the top of the Parasol. You can use safety your Parasol in the windy Weather.

250 gr Olefin, (5 year warranty) and 160 gr acyrlc waterproof polyester Fabric protect you from the Sun for years.

Bases (you can find them on the next and 74-75 th pages)



SMS 200x200/4 SMS 200x200/8 SMS 225x225/8

Boyut / Size	200x200 cm	200x200 cm	225x225 cm
Boru / Tube	Ø 40/37 mm	Ø 40/37 mm	Ø 40/37 mm
Profil / Ribs	13x19 mm	13x19 mm	13x19 mm
Paketleme / Factory Pack	4	4	4

Teknik Özellikleri / Technical Specifications

Ölçü Size	Kapalı Alan Area Covered	Kapalı Yükseklik Height Closed	Etek Yüksekliği Clear Headroom	Açık Yükseklik Height Open	Ambalaj Packaging
A	B m²	C cm	D cm	E cm	Cm
200x200/4	4	60	183	220	27x27x250
200x200/8	4	60	183	220	27x27x250
225x225/8	5	80	163	220	27x27x250

Profiller / Profiles

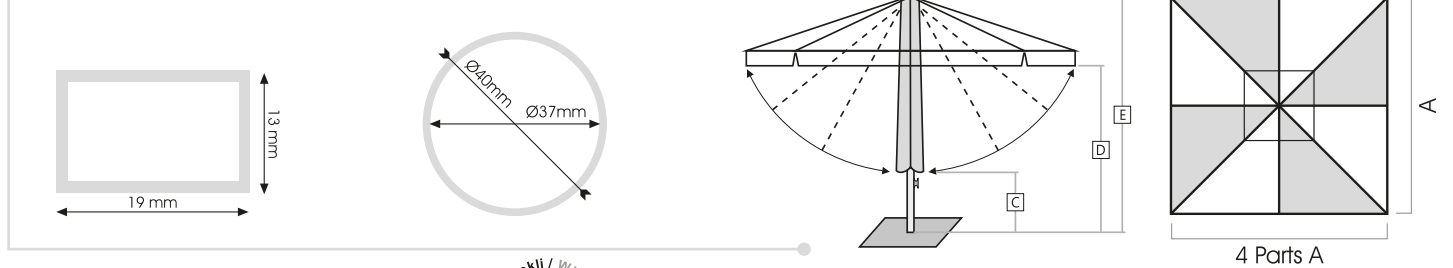



MAXI SUNMINIUM YUVARLAK MAXI SUNMINIUM ROUND

Bahçenizde, havuz kenarında kullanabileceğiniz 8 kollu kare alüminyumdan üretilmiş şemsiyedir.

Beyaz renkli elektrostatik boya (RAL 9010) ile kaplanarak üretilen şemsiyenizin orta borusu 50 mm'dir.

*İskelette bulunan plastik parçalar, tüm dünyada şemsiye üretiminde kullanılan kırılmaya karşı 2 yıl garantili ABS ve POLYAMID PA6 PRIME hammadde kullanılarak üretilmiştir.

Şemsiyenizin rüzgar tahliyesi tepe kısmında bulunan hava pencereleri ile yapılabilirdiği için şemsiyenizi rüzgarlı havalarda güvenle kullanabilirsiniz.

Şemsiyenizi açmak için orta boru üzerinde bulunan plastik gövde mandalını bastırarak yukarı doğru hareketlendirmeniz ve boruda bulunan yuvaya emniyet pimini otomatik olarak oturtmanız yeterlidir.

Kapaması ise mandalın bastırılarak emniyet piminin yuvasından çıkması ile kolayca yapılabilir.

Uygun altlık (Bakınız sayfa 19 ve 74-75) ve 160 gr polyester veya 250 gr olefin (5 yıl garantili) kumaş seçeneği ile sizi yıllarca güneşten koruyabilir.

Sunminyum; square is a aluminum Parasol .

All plastic Parts in the Frame 2 year warranty against Brekage,used in Produktion row Materials same as all over the World, which are manufactured from ABS and POLYAMID PA6 Prime. Centre Pole is 50 diameter and white powder paint coated.

Press a button then push it up to open your Parasol to use it The Wind can be evacuated by air window in the top of the Parasol. You can use safety your Parasol in the windy Weather.

250 gr Olefin, (5 year warranty) and 160 gr acyrlc waterproof polyester Fabric protect you from the Sun for years.

Bases (you can find them on the next and 74-75 th pages)



	MSMR 200/8	MSMR 225/8	MSMR 250/8	MSMR 300/8
Boyut / Size	Ø 200 cm	Ø 225 cm	Ø 250 cm	Ø 300 cm
Boru / Tube	Ø 50/47 mm	Ø 50/47 mm	Ø 50/47 mm	Ø 50/47 mm
Profil / Ribs	19x29 mm	19x29 mm	19x29 mm	19x29 mm
Paketleme / Factory Pack	1	1	1	1

Teknik Özellikleri / Technical Specifications

Ölçü Size	Kapalı Alan Area Covered	Kapalı Yükseklik Height Closed	Etek Yüksekliği Clear Headroom	Açık Yükseklik Height Open	Ambalaj Packaging
A	B m²	C cm	D cm	E cm	Cm
200/8	3	110	163	220	22x22x250
225/8	4	110	163	220	22x22x250
250/8	5	90	183	220	22x22x250
300/8	6	110	190	220	22x22x250

Profiller / Profiles

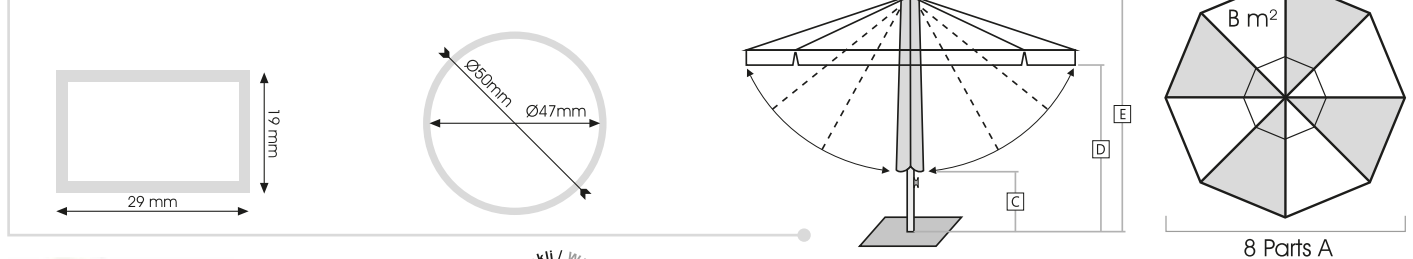

MAXI SUNMINIUM KARE MAXI SUNMINIUM SQUARE



Bahçenizde, havuz kenarında kullanabileceğiniz 8 kollu kare alüminyumdan üretilmiş şemsiyedir.

Beyaz renkli elektrostatik boya (RAL 9010) ile kaplanarak üretilen şemsiyenizin orta borusu Ø50 mm'dir.

*İskelette bulunan plastik parçalar, tüm dünyada şemsiye üretiminde kullanılan kırılmaya karşı 2 yıl garantili ABS ve POLYAMID PA6 PRİME hammadde kullanılarak üretilmiştir.

Şemsiyenizin rüzgar tahliyesi tepe kısmında bulunan hava pencereleri ile yapılabilirdiği için şemsiyenizi rüzgarlı havalarda güvenle kullanabilirsiniz.

Şemsiyenizi açmak için orta boru üzerinde bulunan plastik gövde mandalını bastırarak yukarı doğru hareketlendirmeniz ve boruda bulunan yuvaya emniyet pimini otomatik olarak oturtmanız yeterlidir.

Kapaması ise mandalın bastırılarak emniyet piminin yuvasından çıkması ile kolayca yapılabilir.

Uygun altlık (Bakınız sayfa 21 ve 74-75) ve 160 gr polyester veya 250 gr olefin (5 yıl garantili) kumaş seçeneği ile sizi yıllarca güneşten koruyabilir.

Sunminyum; square is a aluminum Parasol .

All plastic Parts in the Frame 2 year warranty against Brekage,used in Produktion row Materials same as all over the World, which are manufactured from ABS and POLYAMID PA6 Prime. Centre Pole is 50 diameter and white powder paint coated.

Press a button then push it up to open your Parasol to use it The Wind can be evacuated by air window in the top of the Parasol. You can use safety your Parasol in the windy Weather.

250 gr Olefin, (5 year warranty) and 160 gr acyrlc waterproof polyester Fabric protect you from the Sun for years.

Bases (you can find them on the next and 74-75 th pages)



MSMS 200x200/4 MSMS 200x200/8 MSMS 225x225/8 MSMS 250x250/8

Boyut / Size	200x200 cm	200x200 cm	225x225 cm	250x250 cm
Boru / Tube	Ø 50/47 mm	Ø 50/37 mm	Ø 50/37 mm	Ø 50/47 mm
Profil / Ribs	19x29 mm	19x29 mm	19x29 mm	19x29 mm
Paketleme / Factory Pack	1	1	1	1

Teknik Özellikleri / Technical Specifications

Ölçü Size	Kapalı Alan Area Covered	Kapalı Yükseklik Height Closed	Etek Yüksekliği Clear Headroom	Açık Yükseklik Height Open	Ambalaj Packaging
A	B m²	C cm	D cm	E cm	Cm
200x200/4	4	60	183	220	22x22x250
200x200/8	4	60	183	220	22x22x250
225x225/8	5	80	163	220	22x22x250
250x250/8	6	80	160	220	22x22x250

Profiller / Profiles

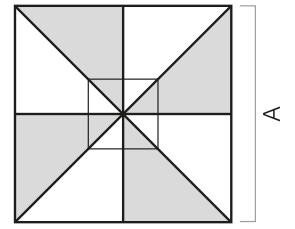
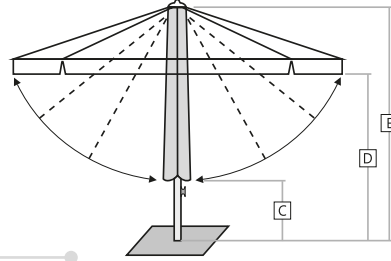
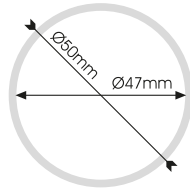
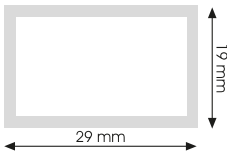



BOND



Bellis Deluxe Hotel / Belek

BOND YUVARLAK BOND ROUND



Bahçenizde, havuz kenarında cafe veya restoranlarınızda sizi güneşten korumak için üretilmiş 8 kollu yuvarlak alüminyum şemsiyedir.

Beyaz renkli elektrostatik boya veya eleksol kaplamalı üretilen şemsiyenizin orta borusu Ø 50 mm'dir.

*İskelette bulunan plastik parçalar, tüm dünyada şemsiye üretiminde kullanılan kırılmaya karşı 2 yıl garantili

ABS ve POLYAMID PA6 PRİME hammadde kullanılarak üretilmiştir.

Şemsiyenizin rüzgar tahliyesi tepe kısmında bulunan hava pencereleri veya tercihinize bağlı üretilen kuleli sistem ile yapılabildiği için şemsiyenizi rüzgarlı havalarda güvenle kullanabilirsiniz.

Şemsiyenizi açmak için üzerinde bulunan ipi aşağı doğru çekmeniz ve şemsiye tam olarak açıldıktan sonra emniyet plastiğine ipi sabitlemeniz yeterlidir.İpin serbest bırakılması ile kolayca kapatılabilir.

Uygun altlık (Bakınız syf 25 ve 74-75) ve 190 gr su iticili kaplamalı polyester veya 250 gr olefin (5 yıl garantili), 300 gr akrilik kumaş ile yıllarca sizi güneşten korur.

Bond round is a aluminum Parasol with 8 Ribs which can be produced to protect you from the Sun in the Garden, Cafes,Restaurants near Pool Edges.

All plastic Parts in the frame 2 year warranty against Brekage,used in Produktion row Materials same as all over the World, which are manufactured from ABS and POLYAMID PA6 Prime.

Anodized or white powder paint coated.the centre Pole is 50 diameter.

Pull down with rope to open your Parasol after when it completely opened then you have to fasten a rope to the safety plastic Part on the Frame.

The Wind can be evacuated by air window in the top of your Parasol and it has a dual roof.

You can use safety your parasol in the windy Weather.

250 gr Olefin, (5 year warranty) and 300 gr acrylic waterproof Polyester and 300 gr acrylic Fabric protect you from the Sun for years.

Bases (you can find them on the next and 70th pages)



Aluminium Etial 60, DYE:Ral 9016
Plastic Material: ABS / PA6

	BR 250/8	BR 300/8	BR 400/8	BR 500/8
Boyut / Size	Ø 250 cm.	Ø 300 cm.	Ø 400 cm.	Ø 500 cm.
Boru / Tube	Ø 47/50 mm	Ø 47/50 mm	Ø 47/50 mm	Ø 46/50 mm
Profil / Ribs	19x29 mm	19x29 mm	19x29 mm	19x29 mm
Paketleme / Factory Pack	1	1	1	1

Güçlendirilmiş orta boru ve fedetli profil / Strengthened ribs and poles

Teknik Özellikleri / Technical Specifications

Ölçü Size	Kapalı Alan Area Covered	İp Sarım Yüksekliği Rope Wrapping Height	Kapalı Yükseklik Height Closed	Etek Yüksekliği Clear Headroom	Toplam Yükseklik Total Height	Ağırlık Weight	Ambalaj Packaging
A	B m ²	C cm	D cm	E cm	F cm	Kg	Cm
250/8	5	50	78	190	250	12	22x22x250
300/8	7	50	78	190	250	13	22x22x250
400/8	12,5	50	60	190	280	20	22x22x280
500/8	20	50	26	220	305	23	22x22x305

Profiller / Profiles

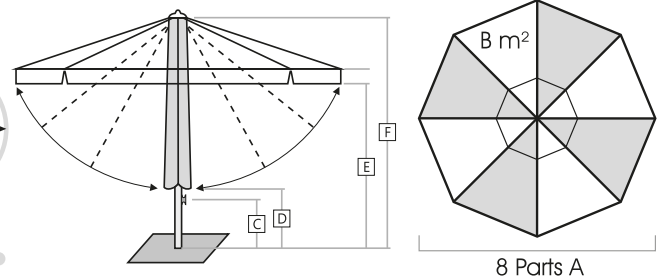
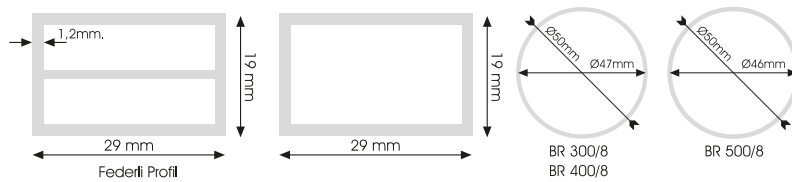

LUCKY STORE SOLUTION
For the life of your business



BOND KARE BOND SQUARE



Bahçenizde, havuz kenarında cafe veya restoranlarınızda sizi güneşten korumak için üretilmiş 8 kollu kare alüminyum şemsiyedir.

Beyaz renkli elektrostatik boya veya eleksol kaplamalı üretilen şemsiyenizin orta borusu Ø 50 mm'dir.

*İskelette bulunan plastik parçalar, tüm dünyada şemsiye üretiminde kullanılan kırılmaya karşı 2 yıl garantili

ABS ve POLYAMID PA6 PRİME hammadde kullanılarak üretilmiştir.

Şemsiyenizin rüzgar tahliyesi tepe kısmında bulunan hava pencereleri veya tercihinize bağlı üretilen kuleli sistem ile yapılabildiği için şemsiyenizi rüzgarlı havalarda güvenle kullanabilirsiniz.

Şemsiyenizi açmak için üzerinde bulunan ipi aşağı doğru çekmeniz ve şemsiye tam olarak açıldıktan sonra emniyet plastiğine ipi sabitlemeniz yeterlidir.İpin serbest bırakılması ile kolayca kapatılabilir.

Uygun altlık (Bakınız syf 27 ve 74-75) ve 190 gr su iticili kaplamalı polyester veya 250 gr olefin (5 yıl garantili), 300 gr akrilik kumaş ile yıllarca sizi güneşten korur.

Bond square is a aluminum Parasol with 8 Ribs which can be produced to protect you from the Sun in the Garden, Cafes,Restaurants near Pool Edges.

All plastic Parts in the frame 2 year warranty against Brekage,used in Produktion row Materials same as all over the World, which are manufactured from ABS and POLYAMID PA6 Prime.

Anodized or white powder paint coated.the centre Pole is 50 diameter.

Pull down with rope to open your Parasol after when it completly opened then you have to fasten a rope to the safety plastic Part on the Frame.

The Wind can be evacuated by air window in the top of your Parasol and it has a dual roof.

You can use safety your parasol in the windy Weather.

250 gr Olefin, (5 year warranty) and 300 gr acyrlc waterproof Polyester and 300 gr acyrlc Fabric protect you from the Sun for years.

Bases (you can find them on the next and 74-75 th pages)



Kuleli / Opsiyonel Dual Roof

	BS 200x200/8	BS 250x250/8	BS 300x300/8	BS 350x350/8	BS 400x400/8
Boyut / Size	200x200 cm.	250x250 cm.	300x300 cm.	350x350 cm.	400x400 cm
Boru / Tube	Ø 47/50 mm	Ø 47/50 mm	Ø 47/50 mm	Ø 46/50 mm	Ø 46/50 mm
Profil / Ribs	19x29 mm	19x29 mm	19x29 mm	19x29 mm	19x29 mm
Paketleme / Factory Pack	1	1	1	1	1

Güçlendirilmiş orta boru ve fedetli profil / Strengthened ribs and poles

Teknik Özellikleri / Technical Specifications

Ölçü Size	Kapalı Alan Area Covered	İp Sarım Yüksekliği Rope Wrapping Height	Kapalı Yükseklik Height Closed	Etek Yüksekliği Clear Headroom	Toplam Yükseklik Total Height	Ağırlık Weight	Ambalaj Packaging
A	B m²	C cm	D cm	E cm	F cm	Kg	Cm
200x200/8	4	50	80	190	250	12	22x22x250
250x250/8	6,25	50	80	190	250	13	22x22x250
300x300/8	9	50	78	195	280	19,5	22x22x280
350x350/8	12,2	50	30	210	300	22	22x22x300
400x400/8	16	50	30	230	335	25	22x22x335

Profiller / Profiles

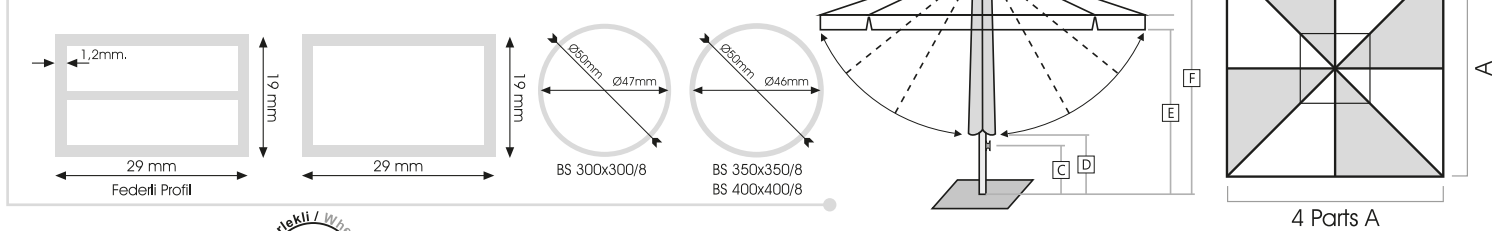





MAKSİ BOND YUVARLAK MAXI BOND ROUND



Bahçenizde, havuz kenarında cafe veya restoranlarınızda sizi güneşten korumak için üretilmiş 8 kollu yuvarlak alüminyum şemsiyedir.

Beyaz renkli elektrostatik boya veya eleksol kaplamalı üretilen şemsiyenizin orta borusu Ø 60 mm'dir.

*İskelette bulunan plastik parçalar, tüm dünyada şemsiye üretiminde kullanılan kırılmaya karşı 2 yıl garantili

ABS ve POLYAMID PA6 PRİME hammadde kullanılarak üretilmiştir.

Şemsiyenizin rüzgar tahliyesi tepe kısmında bulunan hava pencereleri veya tercihinize bağlı üretilen kuleli sistem ile yapılabildiği için şemsiyenizi rüzgarlı havalarda güvenle kullanabilirsiniz.

Şemsiyenizi açmak için üzerinde bulunan ipi aşağı doğru çekmeniz ve şemsiye tam olarak açıldıktan sonra emniyet plastiğine ipi sabitlemeniz yeterlidir. İpin serbest bırakılması ile kolayca kapatılabilir.

Uygun altlık (Bakınız sayı 31 ve 74-75) ve 190 gr su iticili kaplamalı polyester veya 250 gr olefin (5 yıl garantili), 300 gr akrilik kumaş ile yıllarca sizi güneşten korur.

Maxi Bond round is a aluminum parasol with 8 Ribs which can be produced to protect you from the Sun in the Garden, Cafes, Restaurants near Pool Edges.

All plastic Parts in the frame 2 year warranty against Brekage, used in Produktion row Materials same as all over the World, which are manufactured from ABS and POLYAMID PA6 Prime.

Anodized or white powder paint coated. the centre Pole is 60 diameter.

Pull down with rope to open your Parasol after when it completely opened then you have to fasten a rope to the safety plastic part on the frame. The Wind can be evacuated by air window in the top of your Parasol and it has a dual roof.

You can use safety your Parasol in the windy Weather.

250 gr Olefin, (5 year warranty) and 200 gr acyrlie waterproof Polyester and 300gr. acyrlie Fabric protect you from the Sun for years. Bases (you can find them on the next and 74-75 th pages)



Aluminium Etial 60, DYE:Ral 9016
Plastic Material: ABS / PA6

MBR 300/8

MBR 400/8

MBR 500/8

Boyut / Size
Boru / Tube
Profil / Ribs
Paketleme / Factory Pack

Ø 300 cm.
Ø 55/60 mm
20x30 mm
1

Ø 400 cm.
Ø 55/60 mm
20x30 mm
1

Ø 500 cm.
Ø 55/60 mm
20x30 mm
1

Teknik Özellikleri / Technical Specifications

Ölçü Size	Kapalı Alan Area Covered	İp Sarım Yüksekliği Rope Wrapping Height	Kapalı Yükseklik Height Closed	Etek Yüksekliği Clear Headroom	Toplam Yükseklik Total Height	Ağırlık Weight	Ambalaj Packaging
A	B m²	C cm	D cm	E cm	F cm	Kg	Cm
300/8	7	50	78	190	250	13	22x22x250
400/8	12,5	50	60	190	280	20	22x22x280
500/8	20	50	26	220	305	23	22x22x305

Profiller / Profiles

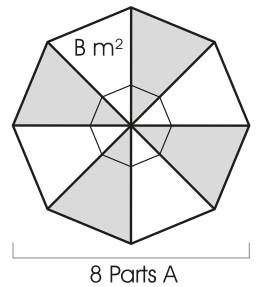
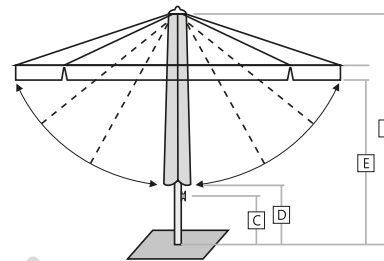
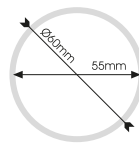
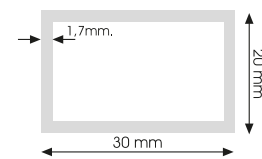

ODS 130
50x50 cm
Yere Monte Yapılabilen
Kaide



ODS 122
70x70 cm / 140 kg
MBR 300/8 - MBR 400/8
İçin Tavsiye Edilir.



ODS 123
80x80 cm / 230 kg
MBR 500/8
İçin Tavsiye Edilir.



ODS 150
80x80 cm / 200 kg
MBR 500/8
İçin Tavsiye Edilir.

MAKSİ BOND KARE MAXI SQUARE



Bahçenizde, havuz kenarında cafe veya restoranlarınızda sizi güneşten korumak için üretilmiş 8 kollu kare alüminyum şemsiyedir.

Beyaz renkli elektrostatik boya veya eleksol kaplamalı üretilen şemsiyenizin orta borusu Ø 60 mm'dir.

*İskelette bulunan plastik parçalar, tüm dünyada şemsiye üretiminde kullanılan kırılmaya karşı 2 yıl garantili ABS ve POLYAMID PA6 PRIME hammadde kullanılarak üretilmiştir.

Şemsiyenizin rüzgar tahliyesi tepe kısmında bulunan hava pencereleri veya tercihinize bağlı üretilen kuleli sistem ile yapılabildiği için şemsiyenizi rüzgarlı havalarda güvenle kullanabilirsiniz.

Şemsiyenizi açmak için üzerinde bulunan ipi aşağı doğru çekmeniz ve şemsiye tam olarak açıldıktan sonra emniyet plastiğine ipi sabitlemeniz yeterlidir. İpin serbest bırakılması ile kolayca kapatılabilir.

Uygun altlık (Bakınız syf 33 ve 74-75) ve 190 gr su iticili kaplamalı polyester veya 250 gr olefin (5 yıl garantili), 300 gr akrilik kumaş ile yıllarca sizi güneşten korur.

Maxi Bond square is a aluminum parasol with 8 Ribs which can be produced to protect you from the Sun in the Garden, Cafes, Restaurants near Pool Edges.

All plastic Parts in the frame 2 year warranty against Brekage, used in Produktion row Materials same as all over the World, which are manufactured from ABS and POLYAMID PA6 Prime.

Anodized or white powder paint coated. the centre Pole is 60 diameter.

Pull down with rope to open your Parasol after when it completly opened then you have to fasten a rope to the safety plastic part on the frame. The Wind can be evacuated by air window in the top of your Parasol and It has a dual roof.

You can use safety your Parasol in the windy Weather.

250 gr Olefin, (5 year warranty) and 200 gr acyrlic waterproof Polyester and 300gr. acyrlic Fabric protect you from the Sun for years. Bases (you can find them on the next and 74-75 th pages)



Kuleli / Opsiyonel Dual Roof



Aluminium Etial 60, DYE:Ral 9016
Plastic Material: ABS / PA6

MBS 300x300/8

MBS 350x350/8

MBS 400x400/8

Boyut / Size
Boru / Tube
Profil / Ribs
Paketleme / Factory Pack

300x300 cm.
Ø 55/60 mm
20x30 mm
1

350x350 cm.
Ø 55/60 mm
20x30 mm
1

400x400 cm
Ø 55/60 mm
20x30 mm
1

Teknik Özellikleri / Technical Specifications

Ölçü Size	Kapalı Alan Area Covered	İp Sarım Yüksekliği Rope Wrapping Height	Kapalı Yükseklik Height Closed	Etek Yüksekliği Clear Headroom	Toplam Yükseklik Total Height	Ağırlık Weight	Ambalaj Packaging
A	B m²	C cm	D cm	E cm	F cm	Kg	Cm
300x300/8	9	50	78	195	280	19,5	22x22x280
350x350/8	12,2	50	30	210	300	22	22x22x300
400x400/8	16	50	30	230	335	25	22x22x335

Profiller / Profiles

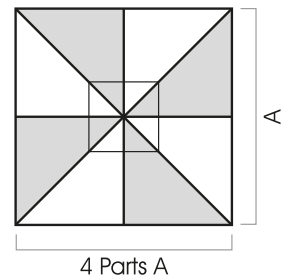
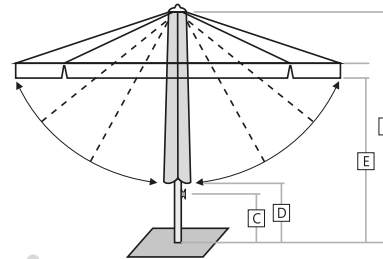
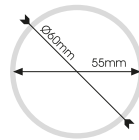
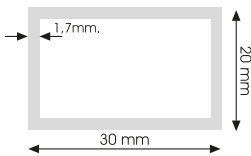

ODS 130
50x50 cm
Yere Monte Yapılabilen
Kaide



ODS 122
70x70 cm / 140 kg
MBS 300x300/8
İçin Tavsiye Edilir.



ODS 123
80x80 cm / 230 kg
MBS 350x350/8 - 400x400/8
İçin Tavsiye Edilir.



ODS 150
80x80 cm / 200 kg
MBS 350x350/8 - 400x400/8
İçin Tavsiye Edilir.



MANUEL TELESCOPIC



MANUEL TELESCOPIC YUVARLAK MANUEL TELESCOPIC ROUND



Cafe –Restaurant-havuz kenarı kullanımına uygun üretilmiştir.

8 kollu yuvarlak teleskopik alüminyum şemsiyedir.

Beyaz renkli elektrostatik boya kaplanarak üretilen şemsiyenizin orta borusu 60 mm. 'dir.

*İskelette kullanılan tüm plastik parçalar tüm dünyada şemsiye üretiminde kullanılan kırılmaya karşı 2 yıl garantili ABS ve POLYAMID PA6 PRİME hammadde kullanılarak üretilmiştir.

Şemsiyenizi açmak için alt gövde plastiği üzerindeki mandalı bastırarak yukarı doğru sürmeniz ve orta boruda bulunan yuvaya emniyet pimini oturtmanız yeterlidir.Kapama yapmanız için mandalın bastırılarak emniyet piminin yuvasından çıkması gerekmektedir.

Uygun altlık (Bakınız syf 37 ve 74-75)ve 190 gr su itici akrilik kaplamalı polyester veya 250 gr olefin (5 yıl garantili) kumaş ile yıllarca sizi güneşten korur.

Manuel telescopic is a round aluminum parasol , which has 8 Ribs and produced for a using in the Cafes, Restaurants and near Pool Edges All plastic Parts in the frame 2 year warranty against Brekage,used in Produktion row Materials same as all over the World, which are manufactured from ABS and POLYAMID PA6 Prime. Centre Pole is 60 diameter.White powder paint coated. Press a button then push it up to open your Parasol to use it The Wind can be evacuated by air window in the top of the Parasol and it has a dualroof.

You can use safety your Parasol in the windy Weather.

250 gr Olefin, (5 year warranty) and 290 gr acyrllic waterproof polyester Fabric protect you from the Sun for years.

Bases (you can find them on the next and 74-75 th pages)

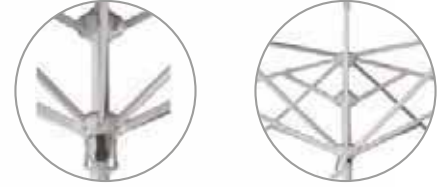

Aluminium Etial 60, DYE:Ral 9016
Plastic Material: ABS / PA6

MTR 300/8 **MTR 400/8**

Boyut / Size	Ø 300 cm	Ø 400 cm
Boru / Tube	Ø 56/60 mm	Ø 56/60 mm
Boru / Tube	39x39 mm	39x39 mm
Profil / Ribs	19x29 mm	19x29 mm
Paketleme / Factory Pack	1	1

Teknik Özellikleri / Technical Specifications

Ölçü Size	Kapalı Alan Area Covered	Kapalı Yükseklik Height Closed	Etek Yüksekliği Clear Headroom	Toplam Yükseklik Total Height	Ağırlık Weight	Ambalaj Packaging
A	B m²	C cm	D cm	E cm	Kg	Cm
300/8	7	120	190	300	18	24x24x300
400/8	12,5	130	190	320	20	24x24x340

Profiller / Profiles

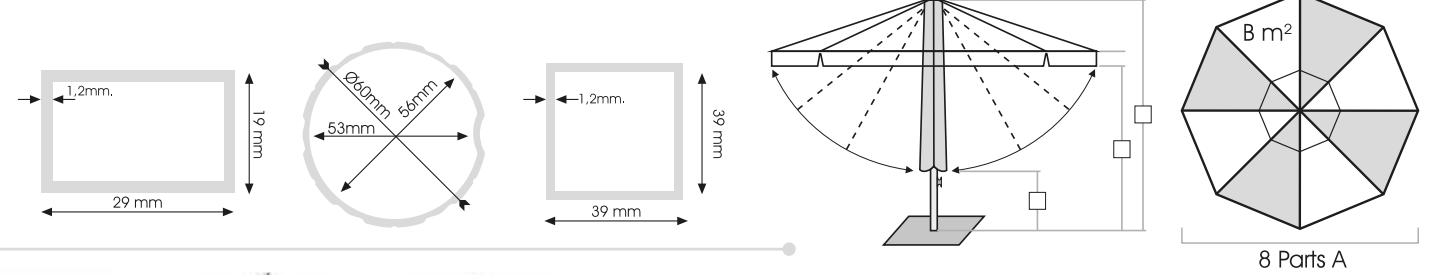

ODS 130
50x50 cm
Yere Monte Yapılabilen
Kaide



ODS 122
70x70 cm / 140 kg
ODS 123
80x80 cm / 230 kg



ODS 150
80x80 cm / 200 kg

MANUEL TELESCOPIC KARE MANUEL TELESCOPIC SQUARE



Cafe –Restaurant-havuz kenarı kullanımına uygun üretilmiştir.

8 kollu kare teleskopik alüminyum şemsiyedir.

Beyaz renkli elektrostatik boya kaplanarak üretilen şemsiyenizin orta borusu 60 mm. 'dir.

*İskelette kullanılan tüm plastik parçalar tüm dünyada şemsiye üretiminde kullanılan kırılmaya karşı 2 yıl garantili ABS ve POLYAMID PA6 PRİME hammadde kullanılarak üretilmiştir.

Şemsiyenizi açmak için alt gövde plastiği üzerindeki mandalı bastırarak yukarı doğru sürmeniz ve orta boruda bulunan yuvaya emniyet pimini oturtmanız yeterlidir.Kapama yapmanız için mandalın bastırılarak emniyet piminin yuvasından çıkması gerekmektedir.

Uygun altlık (Bakınız syf 39 ve 74-75)ve 190 gr su itici akrilik kaplamalı polyester veya 250 gr olefin (5 yıl garantili) kumaş ile yıllarca sizi güneşten korur.

Manuel telescopic square is a aluminum parasol , which has 8 Ribs and produced for a using in the Cafes, Restaurants and near Pool Edges All plastic Parts in the frame 2 year warranty against Brekage,used in Produktion row Materials same as all over the World, which are manufactured from ABS and POLYAMID PA6 Prime. Centre Pole is 60 diameter.White powder paint coated. Press a button then push it up to open your Parasol to use it The Wind can be evacuated by air window in the top of the Parasol and it has a dualroof.

You can use safety your Parasol in the windy Weather.

250 gr Olefin, (5 year warranty) and 290 gr acyrllic waterproof polyester Fabric protect you from the Sun for years.

Bases (you can find them on the next and 74-75 th pages)



Kuleli / Opsiyonel Dual Roof

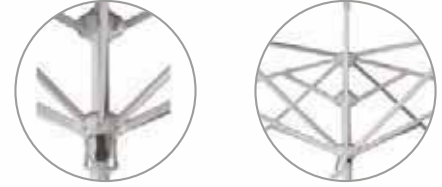

Aluminium Etial 60, DYE:Ral 9016
Plastic Material: ABS / PA6

MTS 300x300/8

MTS 350x350/8

MTS 400x400/8

Boyut / Size
Boru / Tube
Boru / Tube
Profil / Ribs
Paketleme / Factory Pack

300x300 cm
Ø 56/60 mm
39x39 mm
19x29 mm
1

350x350 cm
Ø 56/60 mm
39x39 mm
19x29 mm
1

400x400 cm
Ø 56/60 mm
39x39 mm
19x29 mm
1

Teknik Özellikleri / Technical Specifications

Ölçü Size	Kapalı Alan Area Covered	Kapalı Yükseklik Height Closed	Etek Yüksekliği Clear Headroom	Toplam Yükseklik Total Height	Ağırlık Weight	Ambalaj Packaging
A	B m²	C cm	D cm	E cm	Kg	Cm
300x300/8	9	200	285	325	19	24x24x325
350x350/8	12,5	200	310	360	22	24x24x360
400x400/8	16	200	320	380	24	24x24x380

Profiller / Profiles

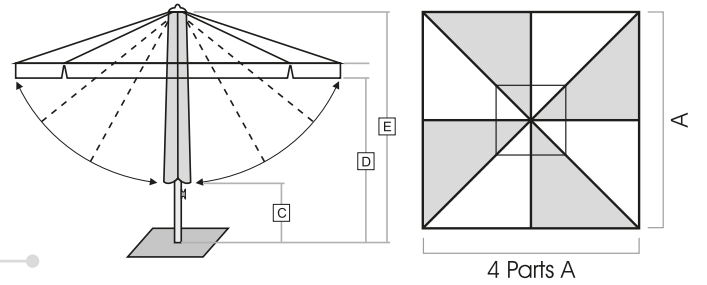
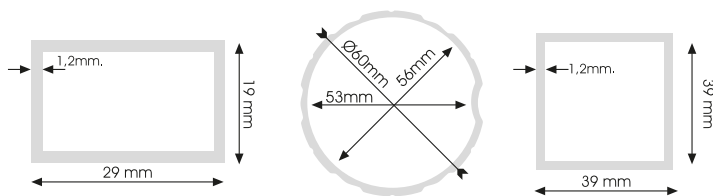

ODS 130
50x50 cm
Yere Monte Yapılabilen
Kaide



ODS 123
80x80 cm / 230 kg
ODS 124
90x90 cm / 230 kg



ODS 150
80x80 cm / 200 kg
ODS 151
90x90 cm / 260 kg



ECO-TELESCOPIC



Ramada / Akbük-Didim

EKO-TELESKOPIK KARE ECO-TELESCOPIC SQUARE



Cafe-Restorant kullanımına uygun teleskopik sistem ile çalışan kare olarak üretilen 8 kollu şemsiyedir. Beyaz veya istenilen RAL renkleriyle elektrostatik boya kaplanabilmekte, gövdesi eloksal olarakta üretilen şemsiyenizin orta borusu 60 mm'dir.

POLYAMID PA6 PRİME hammadde kullanılarak üretilmiştir.

Şemsiyenizin çalışması krank sistemli olup açma veya kapamak için çevirme kolu yardımı ile dişli sistemini harekete geçirmeniz yeterlidir.

Şemsiyemizin rüzgar tahliyesi ister hava pencereleri ile ister kuleli olarak üretilen ana gövde sistemi ile yapılabilmektedir. Uygun altlık (Bakınız sayf 43 ve 74-75) 290 gr su itilici akrilik kaplamalı polyester ve 250 gr olefin (5 yıl garantili) veya 300 gr akrilik kumaş (10 yıl garantili)kumaş ile yıllarca sizi güneşten korur.

Eco Telescopic square is a aluminum parasol with 8 ribs which can be produced for Cafes and Restaurants.

All plastic Parts in the frame 2 year warranty against Brekage,used in produktion row Materials same as all over the World, which are manufactured from ABS and POLYAMID PA6 Prime.

Mechanics; the Gearbox and Spindle contained in the centre of Pole be operated by a crank. Opening and closing by hand crank.

Telescopic opening system that allows an easy closing of the Parasol without moving the Furniture.

Anodized or another colours can be coated, Parasol centre Pole is 60 mm diameter.

The Wind can be evacuated by air window in the top of the Parasol. It has a dual roof.

You can use safety your Parasol in the windy Weather.

250 gr Olefin, (5 year warranty) and 300 gr acrylic protect you from the Sun for years.

Bases (you can find them on the next and 74-75 th pages)



Kuleli / Opsiyonel Dual Roof

Aluminium Etial 60, DYE:Ral 9016
Plastic Material: ABS / PA6

	ETS 300x300/8	ETS 350x350/8	ETS 300x400/8	ETS 400x400/8
Boyut / Size	300x300 cm	350x350 cm	300x400 cm	400x400 cm
Boru / Tube	Ø 55/60 mm	Ø 55/60 mm	Ø 55/60 mm	Ø 55/60 mm
Boru / Tube	Ø 50/53 mm	Ø 50/53 mm	Ø 50/53 mm	Ø 50/53 mm
Profil / Ribs	20x30 mm	20x30 mm	20x30 mm	20x30 mm
Paketleme / Factory Pack	1	1	1	1

Teknik Özellikleri / Technical Specifications

Ölçü Size	Kapalı Alan Area Covered	Krank Yüksekliği Crank Handle Height	Kapalı Yükseklik Height Closed	Etek Yüksekliği Clear Headroom	Açık Yüksekliği Clear Headroom	Toplam Yükseklik Total Height	Ağırlık Weight	Ambalaj Packaging
A	B m ²	C cm	D cm	E cm	F cm	G cm	Kg	Cm
300x300/8	9,0	92	130	190	310	395	25	40x40x395
350x350/8	12,2	92	106	200	310	420	28	40x40x420
300x400/8	12	92	135	200	325	440	30	40x40x440
400x400/8	16	92	110	205	325	440	33	40x40x440

Profiller / Profiles

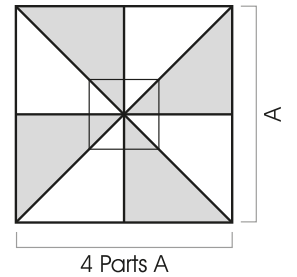
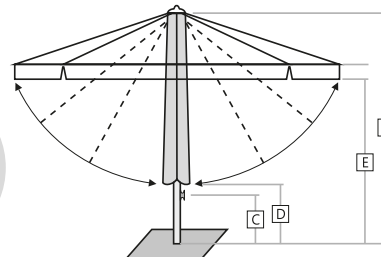
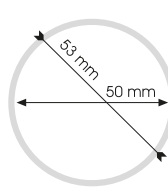
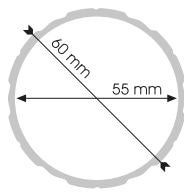
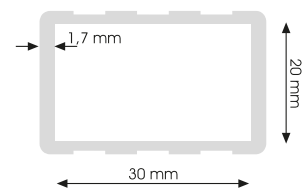

ODS 130
50x50 cm
Yere Monte Yapılabilen
Kaide



ODS 123
80x80 cm / 230 kg
ETS 300x300-350x350
İçin Tavsiye Edilir,



ODS 124
90x90 cm / 270 kg
ETS 300x400-400x400
İçin Tavsiye Edilir,



ODS 150
80x80 cm / 200 kg
ODS 151
90x90 cm / 260 kg
ETS 300x400-400x400
İçin Tavsiye Edilir.

EKO-TELESKOPIK YUVARLAK EKO-TELESCOPIC ROUND

Cafe-Restorant kullanımına uygun teleskopik sistem ile çalışan yuvarlak olarak üretilen 8 kollu şemsiyedir. Beyaz veya istenilen RAL renkleriyle elektrostatik boya kaplanabilmekte, gövdesi eloksalt olarakta üretilen şemsiyenizin orta borusu 60 mm'dir.

*İskelette kullanılan tüm plastik parçalar tüm dünyada şemsiye üretiminde kullanılan kırılmaya karşı 2 yıl garantili ABS ve POLYAMID PA6 PRIME hammadde kullanılarak üretilmiştir.

Şemsiyenizin çalışması krank sistemli olup açma veya kapamak için çevirme kolu yardımı ile dişli sistemini harekete geçirmeniz yeterlidir.

Şemsiyemizin rüzgar tahliyesi ister hava pencereleri ile ister kuleli olarak üretilen ana gövde sistemi ile yapılabilmektedir. Uygun altlık (Bakınız sayfa 45 ve 74-75) 290 gr su itilici akrilik kaplamalı polyester ve 250 gr olefin (5 yıl garantili) veya 300 gr akrilik kumaş (10 yıl garantili)kumaş ile yıllarca sizi güneşten korur.

Eco Telescopic round is a aluminum parasol with 8 ribs which can be produced for Cafes and Restaurants.

All plastic Parts in the frame 2 year warranty against Brekage,used in produktion row Materials same as all over the World, which are manufactured from ABS and POLYAMID PA6 Prime.

Mechanics; the Gearbox and Spindle contained in the centre of Pole be operated by a crank. Opening and closing by hand crank.

Telescopic opening system that allows an easy closing of the Parasol without moving the Furniture.

Anodized or another colours can be coated. Parasol centre Pole is 60 mm diameter.

The Wind can be evacuated by air window in the top of the Parasol. It has a dual roof.

You can use safety your Parasol in the windy Weather.

250 gr Olefin, (5 year warranty) and 300 gr acrylic protect you from the Sun for years.

Bases (you can find them on the next and 74-75 th pages)



Aluminium Etial 60, DYE:Ral 9016
Plastic Material: ABS / PA6

ETR 300/8

ETR 400/8

ETR 500/8

Boyut / Size
Boru / Tube
Boru / Tube
Profil / Ribs
Profil / Ribs
Paketleme / Factory Pack

Ø 300
Ø 55/60 mm
Ø 50/53 mm
20x30 mm
1

Ø 400
Ø 55/60 mm
Ø 50/53 mm
20x30 mm
1

Ø 500
Ø 55/60 mm
Ø 50/53 mm
20x30 mm
1

Teknik Özellikleri / Technical Specifications

Ölçü Size	Kapalı Alan Area Covered	Krank Yüksekliği Crank Handle Height	Kapalı Yükseklik Height Closed	Etek Yüksekliği Clear Headroom	Açık Yüksekliği Clear Headroom	Toplam Yükseklik Total Height	Ağırlık Weight	Ambalaj Packaging
A	B m²	C cm	D cm	E cm	F cm	G cm	Kg	Cm
300/8	7	92	165	190	280	370	20	26x26x370
400/8	12,5	92	145	200	295	410	25	26x26x410
500/8	19,6	92	125	205	310	435	35	26x26x435

Profiller / Profiles

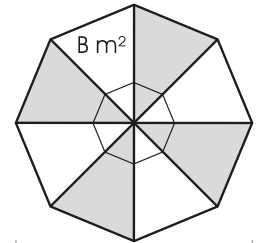
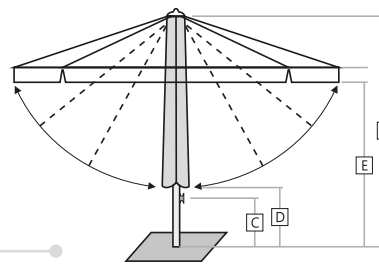
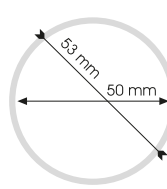
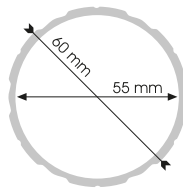
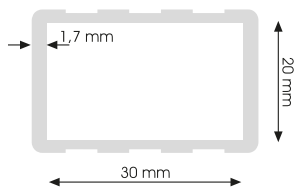

8 Parts A



ODS 130
50x50 cm
Yere Monte Yapılabilen
Kaide



ODS 123
80x80 cm / 230 kg
300/8-400/8
için Tavsiye Edilir.



ODS 124
90x90 cm / 270 kg
500/8
için Tavsiye Edilir.



ODS 150
80x80 cm / 200 kg
300/8-400/8-
için Tavsiye Edilir
ODS 151
90x90 cm / 260 kg
500/8
için Tavsiye Edilir.



LUCKY STORE SOLUTION
For the life of your business





Mall Of İstanbul

ULTRA TELESKOPIK YUVARLAK ULTRA TELESCOPIC ROUND

Cafe-Restorant kullanımına uygun teleskopik sistem ile çalışan yuvarlak olarak üretilen 8 kollu şemsiyedir. Beyaz veya istenilen RAL renkleriyle elektrostatik boya kaplanabilmekte, gövdesi eloksal olarak üretilen şemsiyenizin orta borusu 84 mm'dir.

*İskelette kullanılan tüm plastik parçalar tüm dünyada şemsiye üretiminde kullanılan kırılmaya karşı 2 yıl garantili ABS ve POLYAMID PA6 PRİME hammadde kullanılarak üretilmiştir.

Şemsiyenizin çalışması krank sistemli olup açma veya kapamak için çevirme kolu yardımı ile dişli sistemini harekete geçirmeniz yeterlidir.

Şemsiyemizin rüzgar tahliyesi ister hava pencereleri ile ister kuleli olarak üretilen ana gövde sistemi ile yapılabilmektedir. Uygun altlık (Bakınız syf 49 ve 74-75) 290 gr su itilici akrilik kaplamalı polyester ve 250 gr olefin (5 yıl garantili) veya 300 gr akrilik kumaş (10 yıl garantili)kumaş ile yıllarca sizi güneşten korur.

Ultra Telescopic round is a aluminum parasol with 8 ribs which can be produced for Cafes and Restaurants. All plastic Parts in the frame 2 year warranty against Brekage,used in produktion row Materials same as all over the World,which are manufactured from ABS and POLYAMID PA6 Prime.

Mechanics; the Gearbox and Spindle contained in the centre of Pole be operated by a crank. Opening and closing by hand crank. Telescopic opening system that allows an easy closing of the Parasol without moving the Furniture.

Anodized or another colours can be coated. Parasol centre Pole is 84 diameter.

The Wind can be evacuated by air window in the top of the Parasol. It has a dual roof.

You can use safety your Parasol in the windy Weather.

250 gr Olefin, (5 year warranty) and 300 gr acyrlic protect you from the Sun for years.

Bases (you can find them on the next and 74-75 th pages)



Aluminium Etial 60, DYE:Ral 9016
Plastic Material: ABS / PA6

	UTR 400/8	UTR 500/8	UTR 600/8
Boyut / Size	Ø 400 cm	Ø 500 cm	Ø 600 cm
Boru / Tube	Ø 84/79 mm	Ø 84/79 mm	Ø 84/79 mm
Boru / Tube	Ø 70/66 mm	Ø 70/66 mm	Ø 70/66 mm
Profil / Ribs	34x21,5 mm	34x21,5 mm	34x21,5 mm
Profil / Ribs	33x20,5 mm	33x20,5 mm	33x20,5 mm
Paketleme / Factory Pack	1	1	1

Teknik Özellikleri / Technical Specifications

Ölçü Size	Kapalı Alan Area Covered	Krank Yüksekliği Crank Handle Height	Kapalı Yükseklik Height Closed	Efek Yüksekliği Clear Headroom	Açık Yüksekliği Clear Headroom	Toplam Yükseklik Total Height	Ağırlık Weight	Ambalaj Packaging
A	B m²	C cm	D cm	E cm	F cm	G cm	Kg	Cm
400/8	12,5	92	145	190	290	380	39	26x26x380
500/8	19,6	92	125	200	295	410	46	26x26x410
600/8	28	92	100	205	310	435	60	26x26x435

Profiller / Profiles

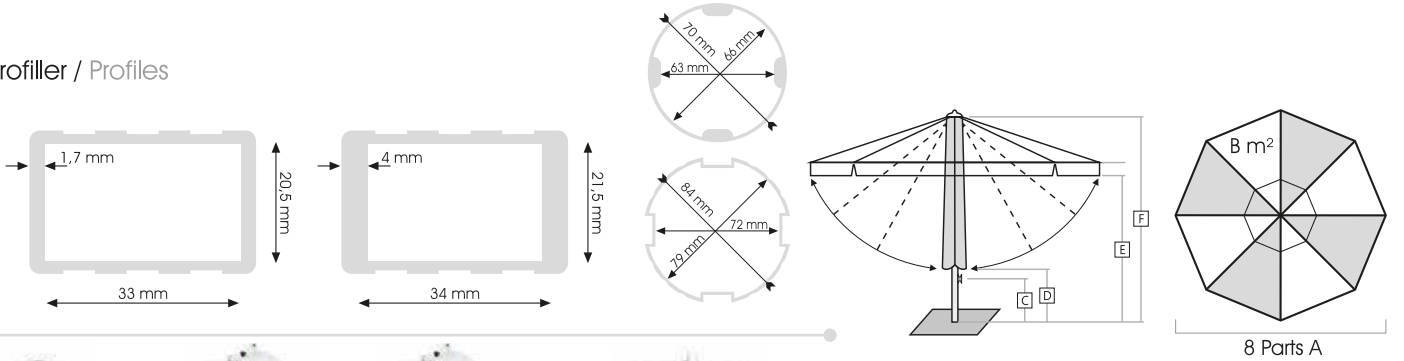

ODS 130
50x50 cm
Yere Monte Yapılabilen
Kaide



ODS 123
80x80 cm / 230 kg
UTR 400/8
İçin Tavsiye Edilir.



ODS 124
90x90 cm / 270 kg
UTR 500/8 - 600/8
İçin Tavsiye Edilir.



ODS 150
80x80 cm / 200 kg
UTR 400/8 İçin Tavsiye Edilir.
ODS 151
90x90 cm / 260 kg
UTR 500/8 - 600/8 İçin Tavsiye Edilir.

ULTRA TELESKOPİK KARE ULTRA TELESCOPIC SQUARE

Cafe-Restorant kullanımına uygun teleskopik sistem ile çalışan kare olarak üretilen 8 kollu şemsiyedir. Beyaz veya istenilen RAL renkleriyle elektrostatik boya kaplanabilmekte, gövdesi eloksal olarak üretilen şemsiyenizin orta borusu 84 mm'dir.

*İskelette kullanılan tüm plastik parçalar tüm dünyada şemsiye üretiminde kullanılan kırılmaya karşı 2 yıl garantili ABS ve POLYAMID PA6 PRİME hammadde kullanılarak üretilmiştir.

Şemsiyenizin çalışması krank sistemli olup açma veya kapamak için çevirme kolu yardımı ile dişli sistemini harekete geçirmeniz yeterlidir.

Şemsiyemizin rüzgar tahliyesi ister hava pencereleri ile ister kuleli olarak üretilen ana gövde sistemi ile yapılabilmektedir. Uygun altlık (Bakınız syf 51 ve 74-75) 290 gr su itilici akrilik kaplamalı polyester ve 250 gr olefin (5 yıl garantili) veya 300 gr akrilik kumaş (10 yıl garantili)kumaş ile yıllarca sizi güneşten korur.

Ultra Telescopic square is a aluminum parasol with 8 ribs which can be produced for Cafes and Restaurants. All plastic Parts in the frame 2 year warranty against Brekage,used in produktion row Materials same as all over the World,which are manufactured from ABS and POLYAMID PA6 Prime.

Mechanics; the Gearbox and Spindle contained in the centre of Pole be operated by a crank. Opening and closing by hand crank. Telescopic opening system that allows an easy closing of the Parasol without moving the Furniture.

Anodized or another colours can be coated. Parasol centre Pole is 84 diameter.

The Wind can be evacuated by air window in the top of the Parasol. It has a dual roof.

You can use safety your Parasol in the windy Weather.

250 gr Olefin, (5 year warranty) and 300 gr acyrlic protect you from the Sun for years.

Bases (you can find them on the next and 74-75 th pages)



Kuleli / Opsiyonel Dual Roof

Aluminium Etial 60, DYE:Ral 9016
Plastic Material: ABS / PA6

	UTS 300X300/8	UTS 350X350/8	UTS 300X400/8	UTS 400X400/8	UTS 450X450/8	UTS 500X500/8
Boyut / Size	300X300/8	350X350/8	300X400/8	400X400/8	450X450/8	500X500/8
Boru / Tube	Ø 84/79 mm	Ø 84/79 mm	Ø 84/79 mm	Ø 84/79 mm	Ø 84/79 mm	Ø 84/79 mm
Boru / Tube	Ø 70/66 mm	Ø 70/66 mm	Ø 70/66 mm	Ø 70/66 mm	Ø 70/66 mm	Ø 70/66 mm
Profil / Ribs	34x21,5 mm	34x21,5 mm	34x21,5 mm	34x21,5 mm	34x21,5 mm	34x21,5 mm
Profil / Ribs	33x20,5 mm	33x20,5 mm	33x20,5 mm	33x20,5 mm	33x20,5 mm	33x20,5 mm
Paketleme / Factory Pack	1	1	1	1	1	1

Teknik Özellikleri / Technical Specifications

Ölçü Size	Kapalı Alan Area Covered	Krank Yüksekliği Crank Handle Height	Kapalı Yükseklik Height Closed	Etek Yüksekliği Clear Headroom	Açık Yüksekliği Clear Headroom	Toplam Yükseklik Total Height	Ağırlık Weight	Ambalaj Packaging
A	B m ²	C cm	D cm	E cm	F cm	G cm	Kg	Cm
300x300/8	9,0	92	130	190	310	395	46	40x40x395
350x350/8	12,2	92	106	200	310	420	49	40x40x420
300x400/8	12	92	135	200	325	440	47	40x40x440
400x400/8	16	92	110	205	325	440	52	40x40x440
450x450/8	20,2	92	110	205	305	420	64	40x40x515
500x500/8	25	80	130	190	320	515	65	40x40x515

Profiller / Profiles

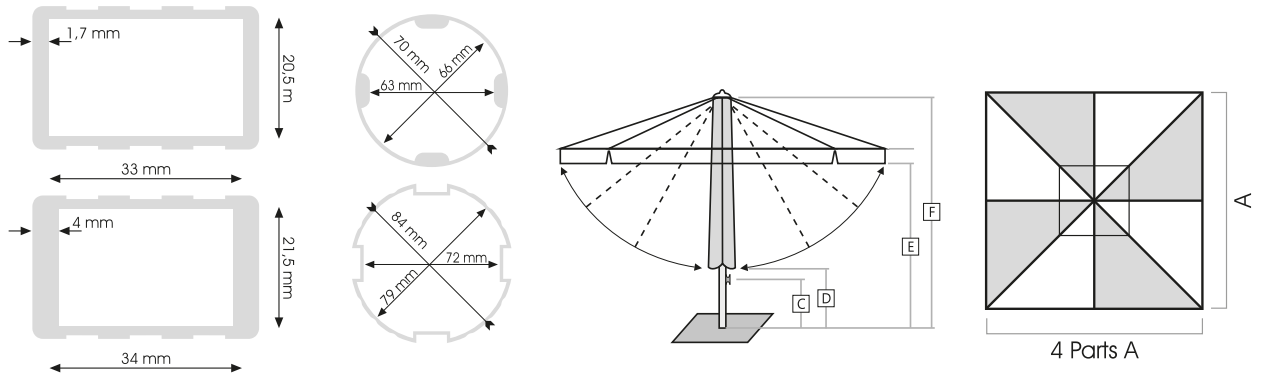

ODS 130
50x50 cm
Yere Monte Yapılabilen
Kaide



ODS 123
80x80 cm / 230 kg
UTS 300x300-350x350-300x400
İçin Tavsiye Edilir.



ODS 124
90x90 cm / 270 kg
UTS 400x400-500x500
İçin Tavsiye Edilir.



ODS 150
80x80 cm / 200 kg
UTS 300x300-350x350-300x400
İçin Tavsiye Edilir.
ODS 151
90x90 cm / 260 kg
UTS 400x400-500x500 İçin Tavsiye Edilir.





SUN DREAM SILVER

Ramada / Akbük-Didim

SUN DREAM SILVER KARE SUN DREAM SILVER SQUARE

Cafe –Restaurant-havuz kenarı kullanımına uygun üretilmiştir.

Şemsiye iskeletinde kullanılan alüminyum Etial 60 dünya standartlarında olup tamamı elektrostatik toz boya ile kaplanmıştır.

Şemsiyenin ana taşıyıcı borusu ile kolları birleştiği çark özel alaşımli alüminyum pres olup kırılmaya karşı dayanıklıdır.

İskeletin alüminyum ile plastik parçalarını birleştiren vidaları paslanmaya karşı çinko nikel kaplama yapılmıştır.

İskelette kullanılan tüm plastik parçalar tüm dünyada şemsiye üretiminde kullanılan kırılmaya karşı 2 yıl garantili ABS ve POLYAMID PA6 PRIME hammadde kullanılarak üretilmiştir.

Şemsiyenin iskeleti üzerinde bulunan kumaş taşıyan kollar 20x40 mm 2,00 mm et kalınlığında olup diğer destek kolları 20x40 2 mm ölçülerinde özel federli alüminyum profilden üretilmiştir.

Şemsiye orta borusu Ø 100 mm çapında olup et kalınlığı 3,5 mm kalınlığındadır.

Şemsiyenin çalışması ana gövdenin içinde yer alan çelik dişli mekanizmasının çevirme kolu ile çevrilerek teleskopik borunun yukarı doğru yükselmesiyle hareketlenir ve şemsiye açılıp kapanırken hiçbir şekilde kullanıcıyı rahatsız etmez.

Uygun altlık (Bakınız syf 55 ve 74-75) 290 gr su itilici akrilik kaplamalı polyester ve 250 gr olefin (5 yıl garantili) veya 300 gr akrilik kumaş (10 yıl garantili)kumaş ile yıllarca sizi güneşten korur.

Sun Dream Silver square is a aluminum parasol with 8 ribs which can be produced for Cafes and Restaurants.

All plastic Parts in the frame 2 year warranty against Brekage,used in Produktion row Materials same as all over the World, which are manufactured from ABS and POLYAMID PA6 Prime.

Mechanics; the Gearbox and Spindle contained in the centre of Pole be operated by a Crank. Opening and Closing by hand Crank.

Telescopic opening System that allows an easy closing of the Parasol without moving the Furniture.

Anodized or another Colours can be coated. Parasol centre Pole is 100 diameter and 3,5 mm thick. Ribs are in size 20x40 mm.

And 2.00 mm thick other supports are made from special aluminum profiles federline in size 20x40 mm.

All the screws of the Frame are stainless.

The Wind can be evacuated by air window in the top of the Parasol and it has a dual roof.

You can use safety your Parasol in the windy Weather.

250 gr Olefin, (5 year warranty) and 300 gr acrylic Fabric protect you from the Sun for years.

Bases (you can find them on the next and 74-75 th pages)



OPSIYONEL

Panel Kontrollü
Motorlu Açılır Kapatılır Sistem
/ Panel controlled motorized opening
and closing system

Aluminium Etial 60, DYE:Ral 9016
Plastic Material: ABS / PA6



Led Sistemi / Led System

	SDS 350X350/8	SDS 400X400/8	SDS 450X450/8	SDS 500X500/8	SDS 600X600/8
Boyut / Size	350x350 cm	400x400 cm	450x450 cm	500x500 cm	600x600 cm
Boru / Tube	Ø 93/100 mm	Ø 93/100 mm	Ø 93/100 mm	Ø 93/100 mm	Ø 93/100 mm
Boru / Tube	Ø 73/66,3 mm	Ø 73/66,3 mm	Ø 73/66,3 mm	Ø 73/66,3 mm	Ø 73/66,3 mm
Profil / Ribs	20x40 mm	20x40 mm	20x40 mm	20x40 mm	20x40 mm
Profil / Ribs	20x40 mm Federli	20x40 mm Federli	20x40 mm Federli	20x40 mm Federli	20x40 mm Federli
Paketleme / Factory Pack	1	1	1	1	1

Teknik Özellikleri / Technical Specifications

Ölçü Size	Kapalı Alan Area Covered	Krank Yüksekliği Crank Height	Kapalı Yükseklik Height Closed	Etek Yüksekliği Clear Headroom	Açık Yüksekliği Clear Headroom	Toplam Yükseklik Total Height	Ağırlık Weight	Ambalaj Packaging
A	B m ²	C cm	D cm	E cm	F cm	G cm	Kg	Cm
350x350/8	12,25	80	130	210	325	425	60	40x40x425
400x400/8	16	80	120	220	335	435	68	40x40x435
450x450/8	20,25	80	100	220	340	450	76	40x40x450
500x500/8	25	80	78	230	364	490	84	40x40x490
600x600/8	36	80	24	250	380	505	91	40x40x505

Profiller / Profiles

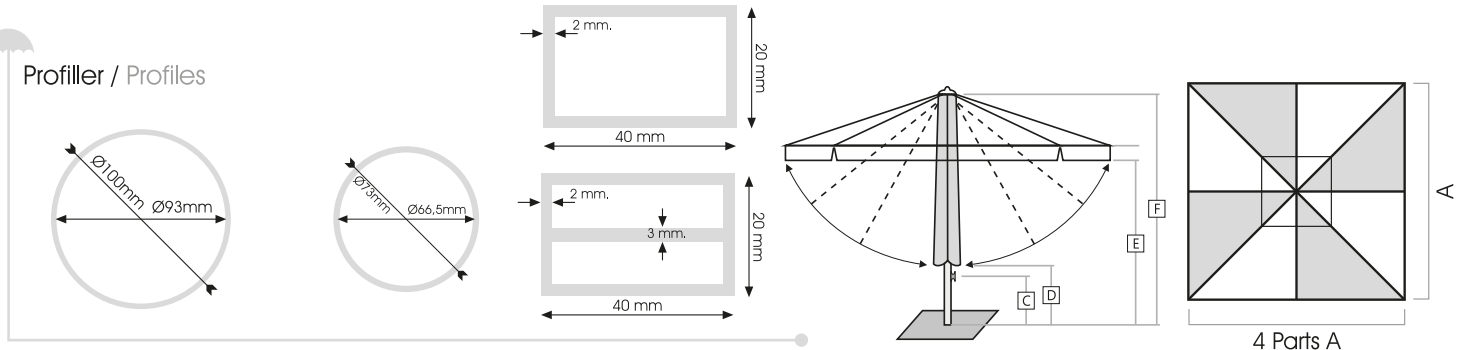

ODS 130
50x50 cm
Yere Monte Yapılabilen
Kaide



ODS 124
90x90 cm / 270 kg
SDS 400x400-500x500
İçin Tavsiye Edilir.



ODS 125
100x100 cm / 350 kg
SDS 600x600
İçin Tavsiye Edilir.



ODS 151
90x90 cm / 260 kg
SDS 400x400-500x500
İçin Tavsiye Edilir.

SUN DREAM SILVER YUVARLAK SUN DREAM SILVER ROUND

Cafe –Restaurant-havuz kenarı kullanımına uygun üretilmiştir.

Şemsiye iskeletinde kullanılan alüminyum Etial 60 dünya standartlarında olup tamamı elektrostatik toz boya ile kaplanmıştır.

Şemsiyenin ana taşıyıcı borusu ile kolları birleştiği çark özel alaşımli alüminyum pres olup kırılmaya karşı dayanıklıdır.

İskeletin alüminyum ile plastik parçalarını birleştiren vidaları paslanmaya karşı çinko nikel kaplama yapılmıştır.

İskelette kullanılan tüm plastik parçalar tüm dünyada şemsiye üretiminde kullanılan kırılmaya karşı 2 yıl garantili ABS ve POLYAMID PA6 PRIME hammadde kullanılarak üretilmiştir.

Şemsiyenin iskeleti üzerinde bulunan kumaş taşıyan kollar 20x40 mm 2,00 mm et kalınlığında olup diğer destek kolları 20x40 2 mm ölçülerinde özel federli alüminyum profilden üretilmiştir.

Şemsiye orta borusu Ø 100 mm çapında olup et kalınlığı 3,5 mm kalınlığındadır.

Şemsiyenin çalışması ana gövdenin içinde yer alan çelik dişli mekanizmasının çevirme kolu ile çevrilerek teleskopik borunun yukarı doğru yükselmesiyle hareketlenir ve şemsiye açılıp kapanırken hiçbir şekilde kullanıcıyı rahatsız etmez.

Uygun altlık (Bakınız syf 57 ve 74-75) 290 gr su itilici akrilik kaplamalı polyester ve 250 gr olefin (5 yıl garantili) veya 300 gr akrilik kumaş (10 yıl garantili)kumaş ile yıllarca sizi güneşten korur.

Sun Dream Silver round is a aluminum parasol with 8 ribs which can be produced for Cafes and Restaurants.

All plastic Parts in the frame 2 year warranty against Brekage,used in Produktion row Materials same as all over the World, which are manufactured from ABS and POLYAMID PA6 Prime.

Mechanics; the Gearbox and Spindle contained in the centre of Pole be operated by a Crank. Opening and Closing by hand Crank.

Telescopic opening System that allows an easy closing of the Parasol without moving the Furniture.

Anodized or another Colours can be coated. Parasol centre Pole is 100 diameter and 3.5 mm thick. Ribs are in size 20x40 mm.

And 2.00 mm thick other supports are made from special aluminum profiles federline in size 20x40 mm.

All the screws of the Frame are stainless.

The Wind can be evacuated by air window in the top of the Parasol and It has a dual roof.

You can use safety your Parasol in the windy Weather.

250 gr Olefin, (5 year warranty) and 300 gr acrylic Fabric protect you from the Sun for years.

Bases (you can find them on the next and 74-75 th pages)



Panel Kontrollü
Motorlu Açılır Kapanır Sistem
/ Panel controlled motorized opening
and closing system

OPSIYONEL



Led Sistemi / Led System

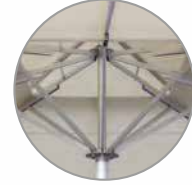

Aluminium Etical 60, DYE:Ral 9016
Plastic Material: ABS / PA6

SDR 500/8

Boyut / Size
Boru / Tube
Boru / Tube
Profil / Ribs
Paketleme / Factory Pack

Ø 500 cm
Ø 93/100 mm
Ø 73/66,3 mm
20x40 mm
1

SDR 600/8

Ø 600 cm
Ø 93/100 mm
Ø 73/66,3 mm
20x40 mm
1

SDR 700/8

Ø 700 cm
Ø 93/100 mm
Ø 73/66,3 mm
20x40 mm Federli
1

Teknik Özellikleri / Technical Specifications

Ölçü Size	Kapalı Alan Area Covered	Krank Yüksekliği Crank Height	Kapalı Yükseklik Height Closed	Etek Yüksekliği Clear Headroom	Açık Yüksekliği Clear Headroom	Toplam Yükseklik Total Height	Ağırlık Weight	Ambalaj Packaging
A	B m²	C cm	D cm	E cm	F cm	G cm	Kg	Cm
500/8	20	80	130	200	305	420	64	40x40x420
600/8	28	80	115	210	320	450	77	40x40x450
700/8	38,5	80	80	215	335	468	86	40x40x468

Profiller / Profiles

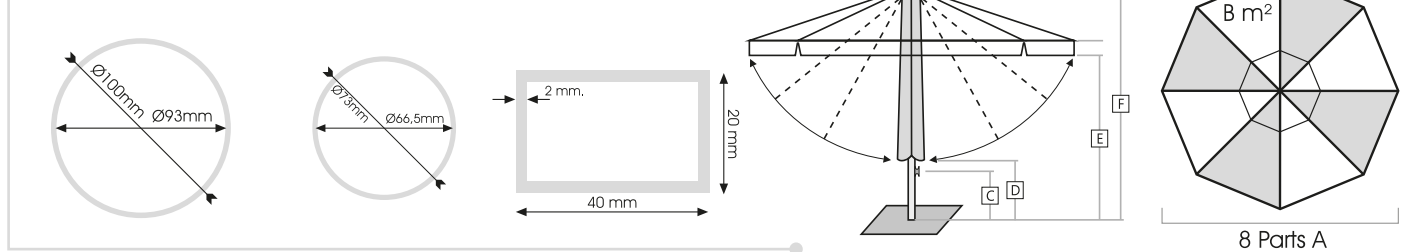

ODS 130
50x50 cm
Yere Monte Yapılabilen
Kaide



ODS 124
90x90 cm / 270 kg
SDR 500/8-600/8
İçin Tavsiye Edilir.



ODS 125
100x100 cm / 350 kg
SDR 700/8
İçin Tavsiye Edilir.



ODS 151
90x90 cm / 260 kg
SDR 500/8-600/8
İçin Tavsiye Edilir.



LUCKY STORE SOLUTION
For the life of your business



SUN DREAM EXCLUSIVE SUN DREAM EXCLUSIVE



Cafe –Restaurant-havuz kenarı kullanımına uygun üretilmiştir.

Şemsiye iskeletinde kullanılan alüminyum Etial 60 dünya standartlarında olup tamamı elektrostatik toz boya ile kaplanmıştır.

Şemsiyenin ana taşıyıcı borusu ile kolları birleştiği çark özel alaşımli alüminyum pres olup kırılmaya karşı dayanıklıdır.

İskeletin alüminyum ile plastik parçalarını birleştiren vidaları paslanmaya karşı çinko nikel kaplama yapılmıştır.

İskelette kullanılan tüm plastik parçalar tüm dünyada şemsiye üretiminde kullanılan kırılmaya karşı 2 yıl garantili ABS ve POLYAMID PA6 PRIME hammadde kullanılarak üretilmiştir.

Şemsiyenin iskeleti üzerinde bulunan kumaş taşıyan kollar 20x40 mm 2,00 mm et kalınlığında olup diğer destek kolları 20x40 2 mm ölçülerinde özel federli alüminyum profilden üretilmiştir.

Şemsiye orta borusu Ø 100 mm çapında olup et kalınlığı 3,5 mm kalınlığındadır.

Şemsiyenin çalışması ana gövdenin içinde yer alan çelik dişli mekanizmasının çevirme kolu ile çevrilerek teleskopik borunun yukarı doğru yükselmesiyle hareketlenir ve şemsiye açılıp kapanırken hiçbir şekilde kullanıcıyı rahatsız etmez.

Uygun altlık (Bakınız syf 57 ve 74-75) 290 gr su itilici akrilik kaplamalı polyester ve 250 gr olefin (5 yıl garantili) veya 300 gr akrilik kumaş (10 yıl garantili)kumaş ile yıllarca sizi güneşten korur.

Sun Dream Silver round is a aluminum parasol with 8 ribs which can be produced for Cafes and Restaurants.

All plastic Parts in the frame 2 year warranty against Brekage,used in Produktion row Materials same as all over the World, which are manufactured from ABS and POLYAMID PA6 Prime.

Mechanics; the Gearbox and Spindle contained in the centre of Pole be operated by a Crank. Opening and Closing by hand Crank.

Telescopic opening System that allows an easy closing of the Parasol without moving the Furniture.

Anodized or another Colours can be coated. Parasol centre Pole is 100 diameter and 3.5 mm thick. Ribs are in size 20x40 mm.

And 2.00 mm thick other supports are made from special aluminum profiles federline in size 20x40 mm.

All the screws of the Frame are stainless.

The Wind can be evacuated by air window in the top of the Parasol and It has a dual roof.

You can use safety your Parasol in the windy Weather.

250 gr Olefin, (5 year warranty) and 300 gr acyrlc Fabric protect you from the Sun for years.

Bases (you can find them on the next and 74-75 th pages)



SDEX 350X350/8

Boyut / Size 350X350 cm
Paketleme / Factory Pack 1

SDEX 350X350/8

400X400 cm
1

Teknik Özellikleri / Technical Specifications

Ölçü Size	Kapalı Alan Area Covered	Krank Yüksekliği Crank Height	Kapalı Yükseklik Height Closed	Etek Yüksekliği Clear Headroom	Toplam Yükseklik Total Height	Ambalaj Ağırlık Packaging Weight
A	B m²	C cm	D cm	E cm	F cm	Kg Cm
350X350/8	12,2	40	275	305-375	375	70 40x40x375
400X400/8	16	40	275	305-375	375	74 40x40x375

Profiller / Profiles

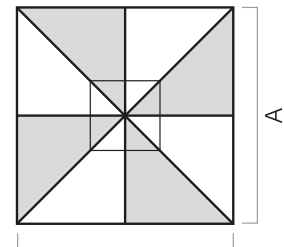
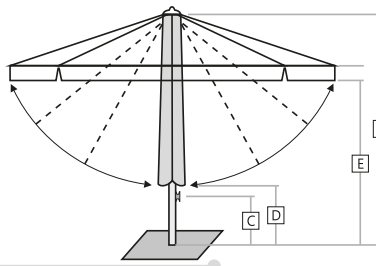
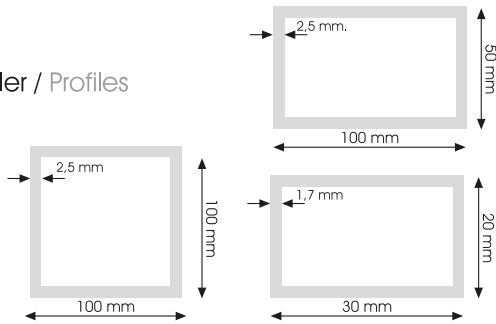

8 Parts A



ODS 125
100x100 cm / 350 kg



TULIBELLA



Bellis Deluxe Hotel / Belek

TULIBELLA



Cafe-Restaurant ve tanıtım kullanımına uygun telescopik sistem ile çalışan kare veya yuvarlak olarak üretilabilen 8 kollu şemsiyedir.

Beyaz veya istenilen RAL renkleriyle elektrostatik boya kaplanabilmekte, gövdesi eloksal olarak üretilen şemsiyenizin orta borusu 84 mm'dir.

*İskelette kullanılan tüm plastik parçalar tüm dünyada şemsiye üretiminde kullanılan kırılmaya karşı 2 yıl garantili ABS ve POLYAMID PA6 PRİME hammadde kullanılarak üretilmiştir.

Şemsiyenizin çalışması krank sistemli olup açma veya kapamak için çevirme kolu yardımı ile dişli sistemini harekete geçirmeniz yeterlidir.

Uygun altlık (Bakınız syf 61 ve 74-75) 290 gr su itilici akrilik kaplamalı polyester ve 250 gr olefin (5 yıl garantili) veya 300 gr akrilik kumaş (10 yıl garantili)kumaş ile yıllarca sizi güneşten korur.

Tulibella is a aluminum parasol with 8 ribs which can be produced for Cafes and Restaurants.

All plastic Parts in the frame 2 year warranty against Brekage,used in produktion row Materials same as all over the World,which are manufactured from ABS and POLYAMID PA6 Prime.

Mechanics; the Gearbox and Spindle contained in the centre of Pole be operated by a crank. Opening and closing by hand crank.

Telescopic opening system that allows an easy closing of the Parasol without moving the Furniture.

Anodized or another colours can be coated. Parasol centre Pole is 84 diameter.

250 gr Olefin, (5 year warranty) and 300 gr acrylic protect you from the Sun for years.

Bases (you can find them on the next and 74-75 th pages)



Aluminium Etial 60, DYE:Ral 9016
Plastic Material: ABS / PA6

	Tulibella 400/8	Tulibella 500/8	Tulibella 600/8
Boyut / Size	Ø 400 cm	Ø 500 cm	Ø 600 cm
Boru / Tube	Ø 84/79 mm	Ø 84/79 mm	Ø 84/79 mm
Profil / Ribs	Ø 34/21,5 mm	Ø 34/21,5 mm	Ø 34/21,5 mm
Paketleme / Factory Pack	1	1	1

Teknik Özellikleri / Technical Specifications

Ölçü Size	Kapalı Alan Area Covered	Krank Yüksekliği Crank Handle Height	Kapalı Yükseklik Height Closed	Toplam Yükseklik Total Height	Ağırlık Weight	Ambalaj Packaging
A	B m²	C cm	D cm	E cm	Kg	Cm
400/8	12,5	92	190	400	37	26x26x400
500/8	20	90	190	450	45	26x26x450
600/8	28	88	190	495	60	26x26x495

Profiller / Profiles

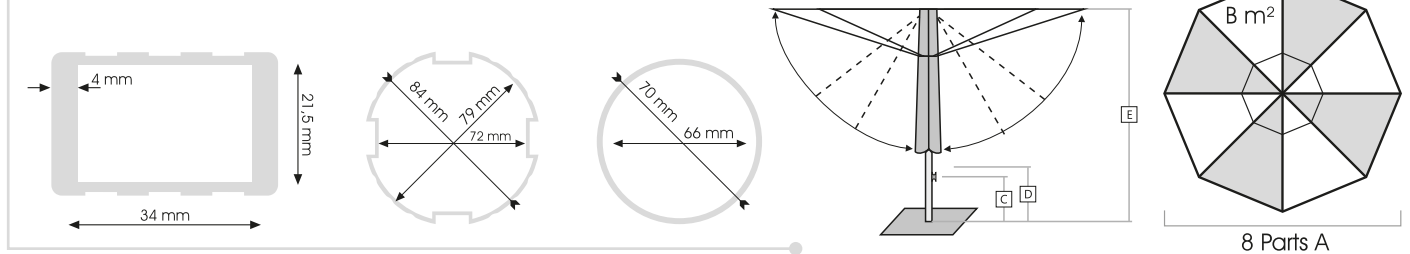

ODS 130
50x50 cm
Yere Monte Yapılabilen
Kaide



ODS 123
80x80 cm / 230 kg
Tulibella 400/8
İçin Tavsiye Edilir.



ODS 124
90x90 cm / 270 kg
Tulibella 500/8-600/8 - 500x500
İçin Tavsiye Edilir.



ODS 150
80x80 cm / 200 kg
Tulibella 400/8 İçin Tavsiye Edilir,
ODS 151
90x90 cm / 260 kg
Tulibella 500/8-600/8 - 500x500
İçin Tavsiye Edilir.



LUCKY STORE SOLUTION
For the life of your business







SUN POLE



SUN POLE YUARLAK SUN POLE ROUND

Cafe –Restorant ve bahçenizde kullanabilmeniz için özel tasarlanmış kare veya yuvarlak üretilen 8 kollu şemsiyedir.

Şemsiye ana gövdesi ahşap desen ile kaplanmış alüminyumdan üretilmiştir.

*İskelette bulunan plastik parçalar, tüm dünyada şemsiye üretiminde kullanılan kırılmaya karşı 2 yıl garantili ABS ve POLYAMID PA6 PRİME hammadde kullanılarak üretilmiştir.

Şemsiyenizin rüzgar tahliyesi tepe kısmında bulunan hava pencereleri ile yapılabildiği için şemsiyenizi rüzgarlı havalarda güvenle kullanabilirsiniz.

Şemsiyenizin çalışması için özel olarak üretilen dişli sistemi hareket ettirilerek çelik halatın şemsiye kollarını açması ile sağlanır.

Özel olarak üretilen altlık ile şemsiyenizi 360° güneşin yönüne döndürebilirsiniz.

Bu ürün için kullanılabilen kumaşlar 290 gr akrilik kaplamalı su itici polyester ve olefin (5 yıl garantili)'dir.

Sun Pole; specially designed by OD S like square or round Parasol with 8 Ribs to use in the Garden, Cafes and Restaurants.

All plastic Parts in the Frame 2 year warranty against Brekage, used in Produktion row Materials same as all over the World which are manufactured from ABS and POLYAMID PA6 Prime. High quality aluminum hubs;

Sun pole equipped with an especially designed, solid aluminum hub in frame color.

Stainless steel cable and winch system;

Open and close freely with an easy turn of the stainless steel crank handle.

Safe and Secure ; the auto locking winch holds the stainless cable at every position. The Frame is wood-like.

The Wind can be evacuated by air window in the top of the Parasol and It has a dual roof.

You can use safely your Parasol in the windy Weather.

250 gr Olefin, (5 year warranty) and 290 gr acrylic waterproof Polyester and 300 gr acrylic Fabric protect you from the Sun for years.

You can rotate your Parasol with special Base to the Direction of 360

Bases (you can find them on the next 74-75 th pages)



Aluminium Etial 60, DYE:Ral 9016
Plastic Material: ABS / PA6

	SP 300/8	SP 350/8
Boyut / Size	Ø 300 cm	Ø 350 cm
Boru / Tube	70x70 mm	70x70 mm
Profil / Ribs	19x29 mm	19x29 mm
Paketleme / Factory Pack	1	1

Teknik Özellikleri / Technical Specifications

Ölçü Size	Kapalı Alan Area Covered	Kapalı Yükseklik Height Closed	Etek Yüksekliği Clear Headroom	Toplam Yükseklik Total Height	Ağırlık Weight	Ambalaj Packaging
A	B m²	C cm	D cm	E cm	Kg	Cm
300/8	7	130	195	295	25	27x27x210
350/8	9,6	120	195	295	28	27x27x210

Profiller / Profiles

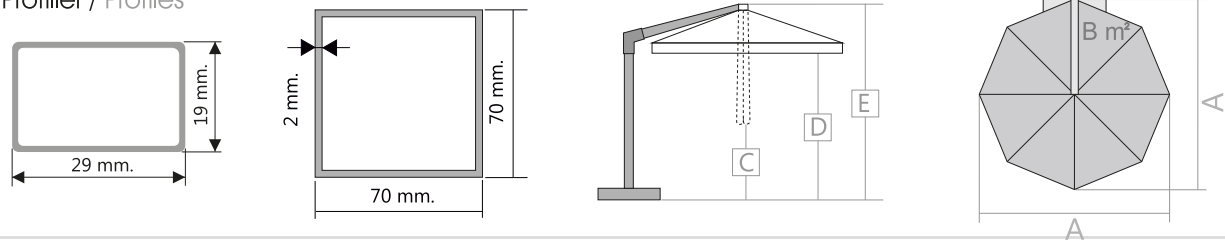

ODS 126
83x83 cm / 180 Kg

SUN POLE KARE SUN POLE ROUND



Cafe –Restorant ve bahçenizde kullanabilmeniz için özel tasarlanmış kare veya yuvarlak üretilen 8 kollu şemsiyedir.

Şemsiye ana gövdesi ahşap desen ile kaplanmış alüminyumdan üretilmiştir.

*İskelette bulunan plastik parçalar, tüm dünyada şemsiye üretiminde kullanılan kırılmaya karşı 2 yıl garantili ABS ve POLYAMID PA6 PRİME hammadde kullanılarak üretilmiştir.

Şemsiyenizin rüzgar tahliyesi tepe kısmında bulunan hava pencereleri ile yapılabildiği için şemsiyenizi rüzgarlı havalarda güvenle kullanabilirsiniz.

Şemsiyenizin çalışması için özel olarak üretilen dişli sistemi hareket ettirilerek çelik halatın şemsiye kollarını açması ile sağlanır.

Özel olarak üretilen altlık ile şemsiyenizi 360° güneşin yönüne döndürebilirsiniz.

Bu ürün için kullanılabilen kumaşlar 290 gr akrilik kaplamalı su itici polyester ve olefin (5 yıl garantili)'dir.

Sun Pole; specially designed by OD S like square or round Parasol with 8 Ribs to use in the Garden, Cafes and Restaurants.

All plastic Parts in the Frame 2 year warranty against Brekage, used in Produktion row Materials same as all over the World which are manufactured from ABS and POLYAMID PA6 Prime. High quality aluminum hubs;

Sun pole equipped with an especially designed, solid aluminum hub in frame color.

Stainless steel cable and winch system;

Open and close freely with an easy turn of the stainless steel crank handle.

Safe and Secure ; the auto locking winch holds the stainless cable at every position. The Frame is wood-like.

The Wind can be evacuated by air window in the top of the Parasol and It has a dual roof.

You can use safely your Parasol in the windy Weather.

250 gr Olefin, (5 year warranty) and 290 gr acrylic waterproof Polyester and 300 gr acrylic Fabric protect you from the Sun for years.

You can rotate your Parasol with special Base to the Direction of 360

Bases (you can find them on the next 74-75 th pages)



Aluminium Etial 60, DYE:Ral 9016
Plastic Material: ABS / PA6

Boyut / Size
Boru / Tube
Profil / Ribs
Paketleme / Factory Pack

SP 300x300

300x300 cm
70x70 mm
19x29 mm
1

Teknik Özellikleri / Technical Specifications

Ölçü Size	Kapalı Alan Area Covered	Kapalı Yükseklik Height Closed	Etek Yüksekliği Clear Headroom	Toplam Yükseklik Total Height	Ağırlık Weight	Ambalaj Packaging
A	B m²	C cm	D cm	E cm	Kg	Cm
300x300/8	9	80	195	295	35	27x27x210

Profiller / Profiles

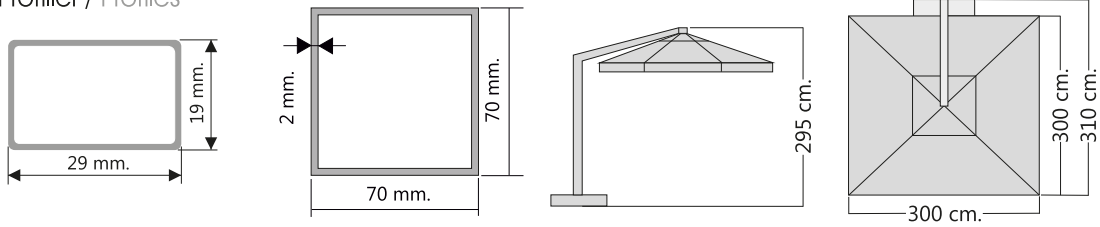

ODS 126
83x83 cm / 180 Kg

SUN POLE KARE 2'Lİ SUN POLE SQUARE 2 SIDE



Cafe –Restorant ve bahçenizde kullanabilmeniz için özel tasarlanmış kare veya yuvarlak üretilen 8 kollu şemsiyedir.

Şemsiye ana gövdesi ahşap desen ile kaplanmış alüminyumdan üretilmiştir.

*İskelette bulunan plastik parçalar, tüm dünyada şemsiye üretiminde kullanılan kırılmaya karşı 2 yıl garantili ABS ve POLYAMID PA6 PRİME hammadde kullanılarak üretilmiştir.

Şemsiyenizin rüzgar tahliyesi tepe kısmında bulunan hava pencereleri ile yapılabildiği için şemsiyenizi rüzgarlı havalarda güvenle kullanabilirsiniz.

Şemsiyenizin çalışması için özel olarak üretilen dişli sistemi hareket ettirilerek çelik halatın şemsiye kollarını açması ile sağlanır.

Özel olarak üretilen altlık ile şemsiyenizi 360° güneşin yönüne döndürebilirsiniz.

Bu ürün için kullanılabilen kumaşlar 290 gr akrilik kaplamalı su itici polyester ve olefin (5 yıl garantili)'dir.

Sun Pole; specially designed by OD S like square or round Parasol with 8 Ribs to use in the Garden, Cafes and Restaurants.

All plastic Parts in the Frame 2 year warranty against Brekage, used in Produktion row Materials same as all over the World which are manufactured from ABS and POLYAMID PA6 Prime. High quality aluminum hubs;

Sun pole equipped with an especially designed, solid aluminum hub in frame color.

Stainless steel cable and winch system;

Open and close freely with an easy turn of the stainless steel crank handle.

Safe and Secure ; the auto locking winch holds the stainless cable at every position. The Frame is wood-like.

The Wind can be evacuated by air window in the top of the Parasol and It has a dual roof.

You can use safely your Parasol in the windy Weather.

250 gr Olefin, (5 year warranty) and 290 gr acrylic waterproof Polyester and 300 gr acrylic Fabric protect you from the Sun for years.

You can rotate your Parasol with special Base to the Direction of 360

Bases (you can find them on the next 74-75 th pages)



Aluminium Etial 60, DYE:Ral 9016
Plastic Material: ABS / PA6

Boyut / Size
Boru / Tube
Profil / Ribs
Paketleme / Factory Pack

SP2 300x300

300x300 cm X 2
90x90 mm
19x29 mm
1

Teknik Özellikleri / Technical Specifications

Ölçü Size	Kapalı Alan Area Covered	Kapalı Yükseklik Height Closed	Etek Yüksekliği Clear Headroom	Toplam Yükseklik Total Height	Ağırlık Weight	Ambalaj Packaging
A	B m²	C cm	D cm	E cm	Kg	Cm
300x300/8	9	80	195	295	45	35x35x230

Profiller / Profiles

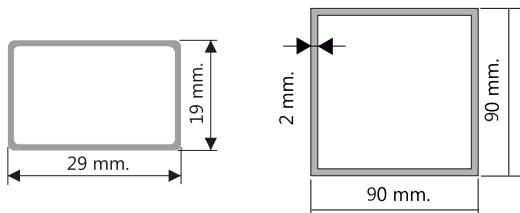
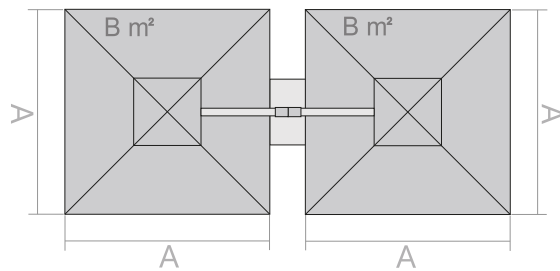
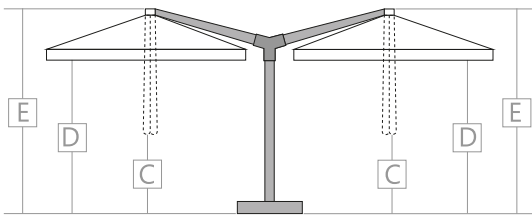

ODS 126
83x83 cm / 180 Kg

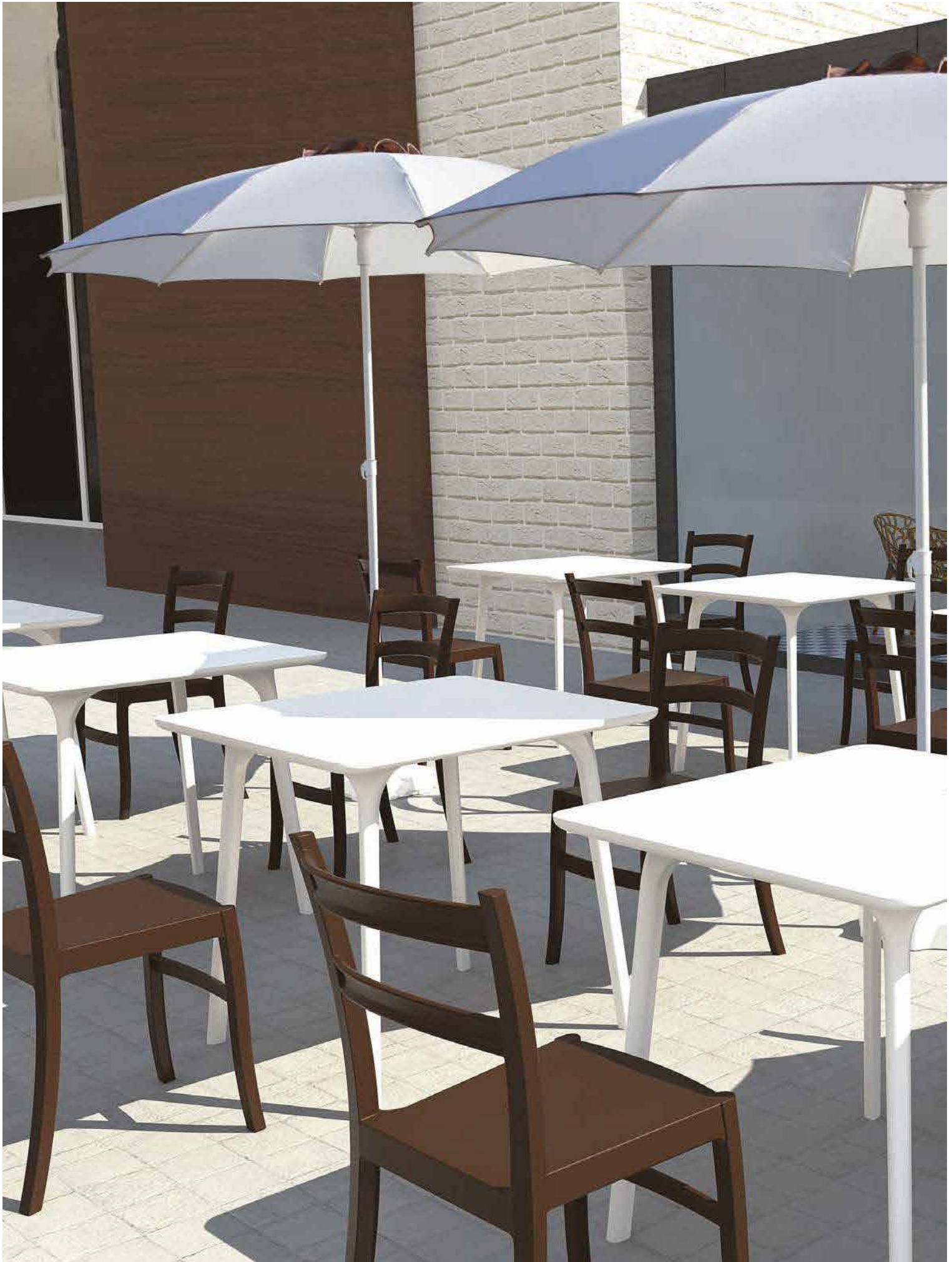

PLAJ ŐEMSİYESİ



PLAJ ŐEMSİYESİ BEACH PARASOL



Bahçenizde, balkonda veya havuz kenarında kullanabileceğiniz 180 cm 8 telli ve 2 mt. çapında 10 telli Őemsiyedir.
Tel kalınlığı 3,8 mm olup yüksek kaliteli karbon çelikten üretilmiştir.

*İskelette bulunan plastik parçalar, tüm dünyada Őemsiye üretiminde kullanılan kırılmaya karşı 2 yıl garantili ABS ve
POLYAMID PA6 PRIME hammadde kullanılarak üretilmiştir.

Açma kapama sistemi bas-bırak mandalı ile kolayca yapılabilmektedir. Őemsiyenizi açmak için mandal bastırılarak yukarı doğru sürülür
ve sabitleyici adaptöre mandal kitlenerek kullanıma hazır hale gelir.

Kapatmak için mandal bastırılarak adaptörden kurtulması sağlanır, Őemsiye kendisini yavaşça kapatır.

Őemsiyenizi güneş yönüne çevirmek 180° head -tilt sistemi sayesinde çok kolaydır.

Őemsiyeniz uygun altlık ve 140 gr akrilik kaplamalı polyester veya 190 gr olefin kumaş (5 yıl garantili) ile sizi yıllarca güneşten koruyabilir.

Beach Parasol produced for Garden,Beach,Advertisement 200 cm in diameter with 10 Wires and 90 cm in diameter with 8 Wires.

All plastic Parts in the Frame 2 year warranty against Brekage,used in Produktion row Materials same as all over the World,
which are manufactured from ABS and POLYAMID PA6 Prime.

Wire tickness is 3.8 mm. made from high quality carbon steel.

Opening and Closing System can be used easily,put up button and press it to open your parasol and for closing press a button to get rid of
the Adapter to close it then Parasol closes itself slowly.

Thanks to the 180° Head- Tilt System it is very easy to turn your Parasol to the Sun Direction

250 gr Olefin, (5 year warranty) and 140 gr acyrlic waterproof polyester Fabric protect you from the Sun for years.

Bases (you can find them on the next and 74-75 th pages)



360° Head Tilt

PLS 180/8

Boyut / Size
Boru / Tube
Tel / Ribs
Paketleme / Factory Pack

Ø 180 cm
22/25 mm
3,80 Ø steel
10/15

PLS 200/8

Ø 200 cm
22/25 mm
3,80 Ø steel
10/15

PLS 200/10

Ø 200 cm
22/25 mm
3,80 Ø steel
10/15

Ambalaj

Packaging

10'lu Koli 26x26x125 cm
15'li Koli 30x30x125 cm



STD 2500
20 lt.



SÜPER 2410
32 lt.



MEGA SP 2060
50 Lt.



MEGA PLAJ ŐEMSİYESİ MEGA BEACH PARASOL

Bahçenizde, balkonda veya havuz kenarında kullanabileceğiniz 230 cm çapında 10 telli Őemsiyedir.

Tel kalınlığı 4,5 mm olup yüksek kaliteli karbon çelikten üretilmiştir.

*İskelette bulunan plastik parçalar, tüm dünyada Őemsiye üretiminde kullanılan kırılmaya karşı 2 yıl garantili ABS ve POLYAMID PA6 PRIME hammadde kullanılarak üretilmiştir.

Őemsiyenizin rüzgar tahliyesi tepe kısmında bulunan hava pencereleri ile yapılabildiği için Őemsiyenizi rüzgarlı havalarda güvenle kullanabilirsiniz.

Açma kapama sistemi bas-bırak mandalı ile kolayca yapılabilmektedir. Őemsiyenizi açmak için mandal bastırılarak yukarı doğru sürülür ve sabitleyici adaptöre mandal kitlenerek kullanıma hazır hale gelir.

Kapatmak için mandal bastırılarak adaptörden kurtulması sağlanır, Őemsiye kendisini yavaşça kapatır.

Őemsiyeniz uygun altlık (Bakınız Syf 73 ve 74-75) ve 160 gr akrilik kaplamalı polyester veya 250 gr olefin kumaş (5 yıl garantili) ile sizi yıllarca güneşten koruyabilir.

Beach parasol produced for garden,beach,advertisement and 230 cm in diameter with 10 wires.

All plastic Parts in the frame 2 year warranty against Brekage,used in Produktion row Materials same as all over the World,which are manufactured from ABS and POLYAMID PA6 Prime. Wire tickness is 4.5 mm. made from high quality carbon steel.

Opening and Closing System can be used easily,put up button and press it to open your Parasol and for closing press a button to get rid of the Adapter to close it then Parasol closes itself slowly.

The Wind can be evacuated by air window in the top of the Parasol. You can use safety your Parasol in the windy Weather.

250 gr Olefin, (5 year warranty) and 160 gr acrylic waterproof polyester Fabric protect you from the Sun for years.

Bases (you can find them on the next and 74-75 th pages)

**MPL 230/10**

Ø 230 cm
29/32 mm
4,5 Ø steel
6

MPL 250/10

Ø 250 cm
29/32 mm
4,5 Ø steel
6

Boyut / Size
Boru / Tube
Tel / Ribs
Paketleme / Factory Pack

Ambalaj
Packaging
6'li Koli 24x24x160 cm

Buzdolabı Şemsiye Aparatı
Fridge Umbrella Holder

SÜPER 2410
32 lt.



MEGA SP 2060
50 Lt.



MEGA S 2310
50 Lt.



ODS 142

STD 2500

Malzeme / Raw Material
HDPE
Yüksek Yoğunluklu Polietilen

Ölçüler / Size
47x47x13 cm

Boş Ağırlık / Weight Empty
0,95 Kg

Kum Dolu Ağırlık / Filled With Sand
40 Kg

Su Dolu Ağırlık / Filled With Water
20 Kg

Boru Ölçüsü / Stick Size
Ø 22 mm
Ø 32 mm

Ambalaj / Packaging
1 Paket: 10 Adet 1 Packet: 10 Pieces
10 Kg. 47x47x130 cm

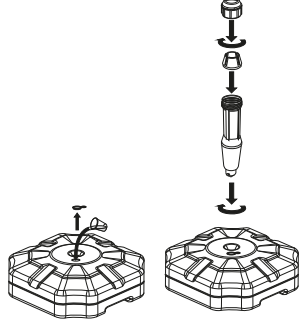

SÜPER 2410

Malzeme / Raw Material
HDPE
Yüksek Yoğunluklu Polietilen

Ölçüler / Size
53x53x16 cm

Boş Ağırlık / Weight Empty
1,45 Kg

Kum Dolu Ağırlık / Filled With Sand
60 Kg

Su Dolu Ağırlık / Filled With Water
30 Kg

Boru Ölçüsü / Stick Size
Ø 22 mm - Ø 32 mm
Ø 38 mm - Ø 40 mm
Ø 42 mm

Ambalaj / Packaging
1 Paket: 5 Adet 1 Packet: 5 Pieces
7,45 Kg. 53x53x80 cm

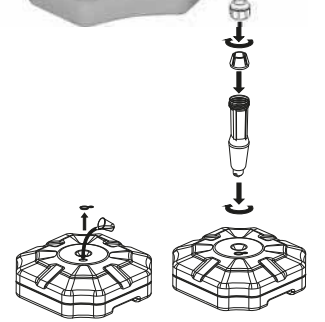

MEGA SP 2060

Malzeme / Raw Material
HDPE
Yüksek Yoğunluklu Polietilen

Ölçüler / Size
53x53x23 cm

Boş Ağırlık / Weight Empty
2,10 Kg

Kum Dolu Ağırlık / Filled With Sand
100 Kg

Su Dolu Ağırlık / Filled With Water
50 Kg

Boru Ölçüsü / Stick Size
Ø 22 mm - Ø 32 mm
Ø 38 mm - Ø 40 mm
Ø 42 mm

Ambalaj / Packaging
1 Paket: 4 Adet 1 Packet: 4 Pieces
8,6 Kg. 53x53x95 cm

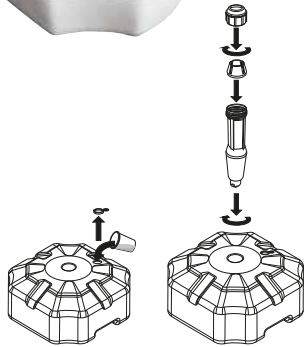

MEGA S 2310

Malzeme / Raw Material
HDPE
Yüksek Yoğunluklu Polietilen

Ölçüler / Size
53x53x23 cm

Boş Ağırlık / Weight Empty
2,75 Kg

Kum Dolu Ağırlık / Filled With Sand
100 Kg

Su Dolu Ağırlık / Filled With Water
50 Kg

Boru Ölçüsü / Stick Size
Ø 32 mm - Ø 36 mm
Ø 40 mm - Ø 50 mm

Ambalaj / Packaging
1 Paket: 4 Adet 1 Packet: 4 Pieces
11,5 Kg. 53x53x110 cm

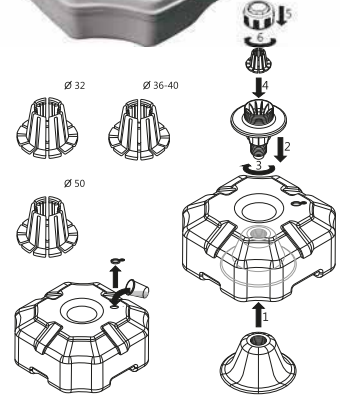

MEGA SP 2060

Malzeme / Raw Material
HDPE
Yüksek Yoğunluklu Polietilen

Ölçüler / Size
31x31x15 cm

Boş Ağırlık / Weight Empty
0,70 Kg

Kum Dolu Ağırlık / Filled With Sand
16 Kg

Su Dolu Ağırlık / Filled With Water
8 Kg

Boru Ölçüsü / Stick Size
Ø 15 mm - Ø 22 mm

Ambalaj / Packaging
1 Paket: 5 Adet 1 Packet: 5 Pieces
3,6 Kg 31x31x75 cm

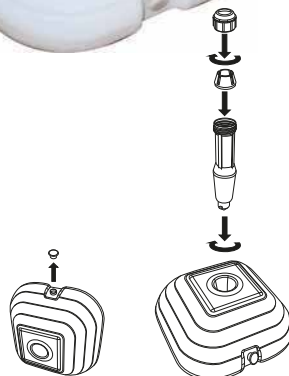

ULTRA S 2720

Malzeme / Raw Material
HDPE
Yüksek Yoğunluklu Polietilen

Ölçüler / Size
62x62x24 cm

Boş Ağırlık / Weight Empty
3,7 Kg

Kum Dolu Ağırlık / Filled With Sand
150 Kg

Su Dolu Ağırlık / Filled With Water
75 Kg

Boru Ölçüsü / Stick Size
Ø 32 mm - Ø 36 mm
Ø 40 mm - Ø 50 mm

Ambalaj / Packaging
1 Paket: 4 Adet 1 Packet: 4 Pieces
15 Kg. 62x62x110 cm

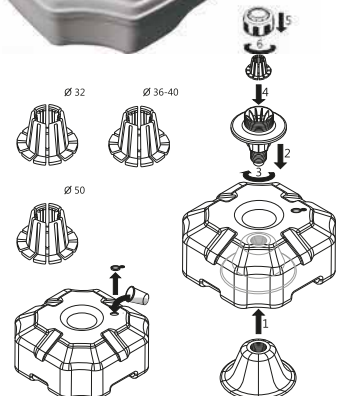

SÜPER / TKR-2412

Ölçüler / Size
52x52x15 cm

Ağırlık / Weight
Filled With Concrete
50 Kg

Beton Dolgulu
Filled With Concrete



ULTRA / TKR-2730

Ölçüler / Size
62x62x15 cm

Ağırlık / Weight
Filled With Concrete
75 Kg

Beton Dolgulu
Filled With Concrete



ODS 150

Ölçüler / Size
80x80 cm
Beton Dolu Ağırlık
Filled With Concrete
200 Kg

Kum Dolu Ağırlık
Filled With Sand
180 Kg

Su Dolu Ağırlık
Filled With Water
100 Kg

Uygun Metal Altlık İle Kullanılır

ODS 151

Ölçüler / Size
90x90 cm
Beton Dolu Ağırlık
Filled With Concrete
260 Kg

Kum Dolu Ağırlık
Filled With Sand
230 Kg

Su Dolu Ağırlık
Filled With Water
130 Kg

Uygun Metal Altlık İle Kullanılır



ODS 142

Buzdolabı Şemsiye Aparatı
Fridge Umbrella Holder



ODS 120

Ölçüler / Size
50x50 cm
Ağırlık / Weight
80 Kg

ODS 121

Ölçüler / Size
60x60 cm
Ağırlık / Weight
100 Kg

ODS 122

Ölçüler / Size
70x70 cm
Ağırlık / Weight
140 Kg



ODS 141

Küllük / Ashtray
Ø 16 cm

ODS 123

Ölçüler / Size
80x80 cm
Ağırlık / Weight
230Kg

ODS 124

Ölçüler / Size
90x90 cm
Ağırlık / Weight
270 Kg

ODS 125

Ölçüler / Size
100x100 cm
Ağırlık / Weight
350 Kg

FONKSİYONEL MASA

Functional Table

Ölçüler / Size
Ø 50 cm

Boru Çapı / Pipe Size
Ø 40 cm
Ø 50 cm



ODS 126

Ölçüler / Size
83x83 cm

Ağırlık / Weight
175 Kg



ODS 130

Ölçüler / Size
50x50 cm

Yere Monte Edilebilen Kaide



ODS DELUX 50

Ölçüler / Size
50x50 cm.
Ağırlık / Weight
80 Kg.



ODS DELUX 65

Ölçüler / Size
65x65 cm.
Ağırlık / Weight
120 Kg.



ODS DELUX 80

Ölçüler / Size
80x80 cm.
Ağırlık / Weight
230 Kg.



LUCKY STORE SOLUTION
For the life of your business

We Design What You Dream



LUCKY STORE SOLUTION
For the life of your business



www.luckystore.ro